



Argo 8x8
Avenger 700

Argo 8x8
Avenger 750 EFI

Argo 8x8
Frontier 650

Argo 6x6 ***Argo 6x6*** ***Argo 6x6***
Frontier 480 ***Frontier 580*** ***Frontier 650***

OPERATOR'S MANUAL

*Do not remove this
manual from this vehicle.*

Safety!
...always in Season!

A MESSAGE FROM THE PEOPLE WHO BUILT YOUR ARGO

Thank you for selecting an **ARGO** amphibious, off-road utility vehicle!

Ontario Drive & Gear Limited has been building **ARGO** vehicles since 1967. By listening carefully to our customers and responding to their needs, we have been constantly improving the **ARGO** and will continue to do so.

Over thirty thousand **ARGO** vehicles have provided reliable service all over the world. From Britain to the Far East, Alaska to the Antarctic, and from the tropical forests of South America to the deserts of Saudi Arabia. We are proud to provide you with a vehicle that represents the ultimate in amphibious, all-terrain transportation.

Your safety and the safety of all **ARGO** users is of the greatest concern to us. You will find numerous safety statements in this manual. Please read and follow them carefully. Always be safety conscious when you operate your **ARGO** and remember it is a motorized vehicle.

The **ARGO** is easy to drive and you will soon be tempted to take on new challenges. Please take the time to develop your driving skills before doing so. Observe the recommendations outlined in this Operator's Manual and remember; some things are just impossible, even with an **ARGO**.

WELCOME TO THE WORLD WIDE ARGO FAMILY!

673-04 Argo Service Manual

673-04CD Argo Service Manual on CD-ROM

673-25 Argo Service Video (Does not include Frontier
or Avenger models)

Ontario Drive & Gear has produced resources which provide the Argo owner with step-by-step instructions on how to perform general service procedures on vehicles produced since 1992. Everything from removal and replacement of brake pads to rebuilding the transmission. It's all there. Removal and replacement of engines is included, however, engine overhaul is not. A separate overhaul manual is available for each engine from your Argo dealer. Order these materials from your selling dealer.

NOTE

Read this manual *before* you operate your ARGO. It contains safe operating instructions and warns the user about potential hazards that can result in personal injury.

Warnings are identified in the text by the following symbol:



Warning text warns the user about potential hazards that can result in personal injury or death.

Cautions are identified in the text by the following symbol:



Caution text contains cautions that can prevent damage to the vehicle.

This manual is based on the latest product information available at the time of printing. Ontario Drive & Gear Limited reserves the right to make changes at any time and without obligation.

Reproduction of any part of this publication is prohibited without prior written permission.

Une version française du manuel d'opération est disponible sous le numéro suivant 671-06FR. Les plaquettes d'avertissement et d'instructions qui apparaissent sur l'Argo sont aussi disponibles en français sous le numéro suivant 126-73.

© 2008 Ontario Drive & Gear Limited

PREFACE

This manual describes the controls, operation and basic maintenance procedures for all AVENGER and FRONTIER models of the ARGO from date of printing. Please take the time to read this manual carefully, for your safety and that of others. By following these instructions, you will ensure extended, trouble free operation of your vehicle.

For maintenance and adjustment of the engine, refer to the engine manufacturer's operation and maintenance manual included in your vehicle's information package.

Before you drive your ARGO, make sure you understand how to use all controls, particularly the brakes and steering system. Learn how to drive your vehicle in an open level area, away from buildings, trees and other obstacles, until you are completely familiar with its operating characteristics. Drive very slowly until your driving skills improve, and drive with caution and consideration at all times. The risk of accident or injury is greatest during the first weeks of use. Take special care during this period. ALWAYS RESPECT OUR ENVIRONMENT.

CAUTION TO THE ARGO OWNER/OPERATOR

- Make sure everyone who drives this vehicle receives proper operating instructions and reads this Operator's Manual.
- No one under the age of 16 should be allowed to operate the ARGO. Children under the age of 16 may not have the skills, abilities or judgement needed to operate the Argo safely and may be involved in an accident causing severe injury or death.
- Never allow anyone under the influence of alcohol or any other intoxicating substance to drive or ride in the vehicle.
- Wear an approved safety helmet and eye protection when driving or riding in the vehicle.
- Special operating and safety procedures described in this manual must be observed before and during water operation as outlined in Section 5.
- When operating your vehicle for extended periods of time, we recommend the use of approved hearing protection.
- Equip your vehicle with a fire extinguisher and a first aid kit.
- Equip your vehicle with basic tools for emergency repairs.
- Before starting your engine, check for spilled gasoline and wipe any up immediately. Gasoline is a potentially explosive substance that can cause serious personal injury when ignited.
- Keep the floor pans secured in place at all times. Fingers, feet, animal tails or paws can be injured in the drive components beneath the floor pans. The floor pans also help keep damaging debris out of the drive components.
- Make sure all passengers remain seated while the vehicle is in motion. Advise your passengers to hold onto the vehicle at all times.
- Never overload your vehicle. Trying to steer an overloaded vehicle can overheat the brakes. This will lead to brake fade which means loss of steering control and the ability to stop the vehicle. Overloading your vehicle can lead to premature brake system failures and costly damage to drive chains, axles or bearings. Follow the recommended load capacity for your vehicle listed in Section 1.
- Do not drive the vehicle at high speeds over unfamiliar or rough terrain. Personal injury or vehicle damage may result.
- Certain terrain and steep hills cannot be traversed safely with the Argo or any other vehicle. Do not attempt to drive over terrain that is questionable.
- Avoid driving your vehicle on asphalt or concrete roadways when possible. When the vehicle turns, its tires skid on the driving surface. Asphalt or concrete causes extensive tire wear.
- Use common sense at all times when driving your vehicle.
- The Argo engine hood is designed to stay fastened in place while the vehicle is being driven. If the Argo is transported by truck or trailer, the hood should be removed and carried in the transport vehicle or secured in place on the Argo with rope or tie down straps. Wind or turbulence at road speeds could result in the loss of the hood.

IMPORTANT

Operate this vehicle with safety constantly in mind. Off-road vehicles face unpredictable and often hazardous terrain conditions. It is ultimately the operator's responsibility to handle the vehicle safely within its limitations and to decide when and where to travel.

TABLE OF CONTENTS

SECTION		PAGE
1.0	GENERAL INFORMATION	
1.1	AMPHIBIOUS OPERATION.....	1
1.2	MAINTENANCE PROCEDURES	1
1.3	WIND CHILL FACTOR	1
1.4	MODEL IDENTIFICATION	1
1.4.1	Argo Vehicle Capacity	3
1.5	REAR SEATS - 8 WHEEL MODELS.....	3
1.6	IDENTIFICATION AND LOCATION OF CONTROLS.....	4
1.7	INFORMATION LABELS	5
2.0	GENERAL OPERATING INSTRUCTIONS	
2.1	NEW VEHICLE “BREAK-IN” PROCEDURE	6
2.2	PRE-OPERATION CHECKS	6
2.3	CARRYING PASSENGERS AND CARGO.....	6
2.4	OPERATORS WITH DISABILITIES.....	7
2.5	FUELING THE VEHICLE.....	8
2.6	VENTED FUEL SYSTEM - ALL MODELS.....	8
2.7	INSTRUMENT CLUSTER	9
3.0	OPERATING INSTRUCTIONS	
3.1	BRAKES AND STEERING	10
3.2	HOLDING BRAKE SYSTEM	10
3.3	THROTTLE CONTROL	10
3.4	STARTING PROCEDURE.....	10
3.5	NEUTRAL START SWITCH.....	11
3.6	PRIMING THE ENGINE FOR AVENGER EFI.....	11
3.7	STOPPING THE ENGINE	11
3.8	MANUAL STARTING PROCEDURE	11
3.9	SELECTING AND CHANGING TRANSMISSION GEARS	12
3.9.1	Changing Transmission Gears	12
3.10	HEADLIGHTS	12
4.0	DRIVING PROCEDURES	
4.1	DRIVING STRAIGHT AHEAD	13
4.2	STOPPING THE VEHICLE	13
4.3	TURNING THE VEHICLE	13
4.3.1	Left Turn	13
4.3.2	Right Turn	13
4.4	BACKING THE VEHICLE UP.....	13
4.4.1	Turning the Vehicle While Backing Up.....	13
5.0	DRIVING PROCEDURES DURING UNUSUAL CONDITIONS	
5.1	REMOTE AREA USE	14
5.2	ANGLE OF OPERATION.....	14
5.3	UPHILL OPERATION	14
5.4	DOWNHILL OPERATION	14
5.5	SIDE SLOPE OPERATION	15
5.6	AMPHIBIOUS OPERATION - GENERAL.....	15
5.6.1	Entering Water	16
5.6.2	Driving Procedures in Water.....	16
5.6.3	Driving Out of Water	16
5.6.4	Outboard Motor Bracket.....	16

TABLE OF CONTENTS

SECTION		PAGE
5.7	WINTER OPERATION	17
5.7.1	Use on Ice Covered Bodies of Water	17
6.0	OIL, FILTER AND LUBRICATION INFORMATION	
6.1	ENGINE OIL INFORMATION	18
6.1.1	CHECKING THE ENGINE OIL LEVEL	18
6.1.2	RECOMMENDED ENGINE OIL.....	18
6.1.3	CHANGING ENGINE OIL.....	19
	Draining the Engine Oil.....	19
	Refilling the Engine	19
6.2	TRANSMISSION OIL INFORMATION	19
6.2.1	CHECKING THE TRANSMISSION OIL LEVEL	19
6.2.2	CHANGING THE TRANSMISSION OIL	20
	Refilling the Transmission	20
6.3	FILTER INFORMATION	20
6.3.1	AIR FILTER	20
6.3.2	FUEL FILTER	20
6.3.3	OIL FILTER.....	20
6.4	LUBRICATION INFORMATION.....	21
6.4.1	GENERAL.....	21
6.4.2	CLUTCH LUBRICATION.....	21
6.4.3	DRIVE CHAIN LUBRICATION	21
6.4.4	IDLER CHAIN LUBRICATION	21
6.4.5	OUTER AXLE FLANGE AND BEARING LUBRICATION	22
6.4.6	IDLER SHAFT BEARING LUBRICATION	22
6.4.7	INNER AXLE BEARING LUBRICATION	22
7.0	MAINTENANCE INFORMATION	
7.1	ELECTRICAL SYSTEM.....	23
7.1.1	GENERAL.....	23
7.1.2	BATTERY - Argo Part No. 127-54.....	23
	Checking Fluid Level	23
	Charging the Battery.....	23
	Cleaning the Battery Terminals and Cable Connections	23
	Cleaning the Battery	24
7.1.3	ELECTRICAL SYSTEM FUSES	24
7.1.4	SPARK PLUGS	24
7.1.5	SPARK ARRESTER.....	24
7.2	DRIVE SYSTEM & TIRES.....	24
7.2.1	DRIVE BELT.....	24
	Drive Belt Removal	25
	Drive Belt Installation.....	25
7.2.2	CLUTCH MAINTENANCE	25
	Clutch Inspection	25
7.2.3	DRIVE CHAINS	26
	Drive Chain Removal	26
	Drive Chain Installation.....	26
7.2.4	DRIVE CHAIN TAKE-UP SYSTEM	27

TABLE OF CONTENTS

SECTION	PAGE
	Replacement of Slider Blocks28
7.2.5	IDLER CHAIN28
	Idler Chain Adjustment29
	Removal of Idler Chains29
	Installation of Idler Chains29
7.2.6	TIRE INFLATION29
7.2.7	TIRE REPAIR AND REPLACEMENT30
7.2.8	AXLE BEARING MOUNTING30
7.3	HYDRAULIC BRAKES31
7.3.1	GENERAL31
7.3.2	BRAKE FLUID LEVEL31
7.3.3	CHANGING BRAKE FLUID31
7.3.4	HYDRAULIC BRAKE PAD INSPECTION31
	Firewall Removal31
	Brake Pad Inspection Procedure32
	Re-installation of Brake Pads32
	Re-installation of Firewall32
7.3.5	HAND BRAKE ADJUSTMENT32
7.3.6	EMERGENCY/PARKING BRAKE ADJUSTMENT33
7.3.7	BRAKE PLUNGER ADJUSTMENT34
7.3.8	BRAKE COOLING SYSTEM35
7.3.9	ENGINE COOLING & EXHAUST SYSTEM35
7.4	MAINTENANCE SCHEDULE36
8.0	TROUBLESHOOTING37
9.0	CLEANING AND STORAGE
9.1	CLEANING THE VEHICLE39
9.2	STORING THE VEHICLE39
	Cleaning the Vehicle39
	Drain the Fuel System39
	Prepare the Battery for Storage39
	Protect the Electrical System39
	Raise the Vehicle39
	Preparing the Engine for Storage39
10.0	POTENTIAL HAZARDS40
11.0	ACCESSORY INFORMATION
11.1	GENERAL44
11.2	CARGO TIE-DOWNS (Part No. 614-06)44
11.3	ARGO TRACK SYSTEMS (Standard Track and Super Track)44
	11.3.1 Assembly Instructions44
	11.3.2 Installing the Axle Extension (Super Track & Rubber Track)45
	11.3.3 Standard and Super Track Installation47
	11.3.4 Removal of Standard and Super Tracks47
	11.3.5 Operating Precautions (All Track Systems)48
	11.3.6 Standard Tracks48

TABLE OF CONTENTS

SECTION	PAGE
11.3.7 Super Tracks	48
11.3.8 Rubber Tracks	48
11.3.9 Installation Instructions (625-50 & 825-50-1 Rubber Track Systems)	48
11.3.10 Removal of 625-50 & 825-50-1 Argo Rubber Track Systems	50
11.4 ICE CLEAT KIT (Part Nos. 625-20, 825-20 & 825-21)	50
11.5 OUTBOARD MOTOR BRACKET - SIDE MOUNT (Part No. 617-09 & 617-10).....	50
11.6 ARGO STORAGE COVERS (Part Nos. 621-21; 821-20 & 821-40)	51
11.7 POWER WINCH (Part Nos. 622-105 & 622-110).....	51
11.7.1 Rules for Safe Operation	51
11.7.2 Tips for Extending the Life of Your Winch	53
11.8 REAR MUD FLAP KIT (Part No. 625-10).....	53
11.9 BILGE PUMP KIT (Part No. 638-30).....	53
11.10 HANDRAIL KITS (Part No. 639-26; 839-30 & 839-35).....	53
11.11 TOW HOOK KIT (Part No. 642-00).....	53
11.12 WINDSHIELD (Part No. 648-79 & 648-80).....	54
11.13 CONVERTIBLE TOP (Part Nos. 649-51; 849-40 , 849-45 & 849-51).....	54
11.14 ALTERNATOR KIT for Avenger (Part No. 850-54).....	55
11.15 SNOW PLOW KIT (Part No. 657-21).....	55
11.16 AMPHIBIOUS TRAILER (Part No. 695-75 & 695-80BL).....	55
11.16.1 Operating Precautions.....	55
11.17 HEATER KIT - Avenger (Part No. 848-32).....	55
11.18 ROLL OVER PROTECTIVE STRUCTURES (Part Nos. 648-47; 848-40-2; 848-40-4; 849-90-2 & 849-90-4).....	56
11.19 REAR BENCH SEAT (Part No. 849-80)	56
11.20 ROLL BAR KIT (Part No. 648-15).....	57
11.21 12V ACCESSORY OUTLET KIT (Part No. 633-25)	57
11.22 BRUSHGUARD KIT (Part No. 642-20 & 642-40).....	57
 APPENDIX	
1 SPECIAL TOOLS	
VICE GRIP MODIFICATIONS	58

SECTION 1

GENERAL INFORMATION

1.1 AMPHIBIOUS OPERATION

All models of the ARGO are amphibious and capable of traversing calm water. Special operating procedures and safety precautions must be observed before entering the water and during amphibious operation. Do not drive your vehicle into water until you have read Section 5.6 Amphibious Operation.

Operators with disabilities need to take certain precautions in the interest of their own safety. Refer to Section 2.4 of this manual for more details.

1.2 MAINTENANCE PROCEDURES

Maintenance procedures described in this manual can be carried out by the operator. These procedures include:

1. checking fluid levels
2. changing the engine and transmission oil
3. cleaning and replacing filters
4. preventative maintenance
5. inspections, adjustments, repairs and trouble-shooting

If you perform your own maintenance, carefully follow the lubrication and preventative maintenance schedule (Section 7.5). By following this schedule, you will receive trouble free, long term service from your vehicle. The following comprehensive ARGO service information is available:

- 673-00 1977-1986 ARGO Service Manual
- 673-01 1987 ARGO Service Manual
- 673-02 1988 Supplement
- 673-04 Service Manual 1992 - CURRENT
- 673-04CD Service Manual on CD-ROM 1992 - CURRENT
- 673-25 Argo Service Video 1992-2000

Your Argo dealer will perform regular maintenance and lubrication for a reasonable service charge.

The trouble-shooting chart (Section 8) contains information for locating and correcting mechanical problems. In many cases, potential problems can be identified by unusual noises, sluggishness or vibration, before they result in a breakdown. Refer to the chart to identify these symptoms. Take immediate corrective action or take the vehicle to an Argo dealer for service.

This manual does not provide detailed maintenance or servicing information for the engine. Refer to the engine manufacturer's manual (supplied with each Argo) for important warranty, service and operating information.

If the engine requires servicing, take the vehicle to an authorized engine service outlet.

1.3 WIND CHILL FACTOR

Why does it feel much colder outdoors on a windy day than when there's no wind, especially in winter?

The cooling effect of the wind makes it feel that it's colder than it really is. This combined effect of wind and low temperature is known as the "wind chill factor".

Argo operators should be aware of the wind chill factor. Dress warmly and make sure exposed skin is protected. Pay particular attention that young passengers are properly "bundled up" with their hands and faces well protected.

WIND CHILL									
Wind Speed									
km/h	8	16	24	32	40	48	56	64	
Actual Temp.(C)									Gradually
0	-2	-8	-11	-14	-16	-17	-19	-19	Increasing
-5	-7	-14	-18	-21	-23	-25	-26	-27	Danger
-10	-12	-20	-25	-28	-31	-33	-34	-35	Dangerous
-15	-18	-26	-32	-35	-38	-40	-42	-43	
-20	-23	-32	-38	-43	-46	-48	-50	-51	
-25	-28	-38	-45	-50	-53	-56	-57	-59	Extremely
-30	-33	-45	-52	-57	-61	-63	-65	-67	Dangerous
-35	-39	-51	-59	-64	-68	-71	-73	-75	
-40	-44	-57	-65	-71	-75	-79	-81	-83	
-45	-49	-63	-72	-78	-83	-86	-89	-90	
-50	-54	-69	-79	-85	-90	-94	-96	-98	

1.4 MODEL IDENTIFICATION

Vehicles are identified by a 17 digit vehicle identification number - reference Section 1.6 for exact location. The last 6 digits of this number begin with one of the following prefix:

- V - 8x8 Avenger 700
- H - 8x8 Avenger 750 EFI
- J - 8x8 Frontier 650
- F - 6x6 Frontier 650
- M - 6x6 Frontier 580
- L - 6x6 Frontier 480

SECTION 1

GENERAL INFORMATION

Carefully observe the maximum load capacity for your vehicle on land and in water as listed in the following:

8x8 AVENGER 700 (V)

Engine: Kohler 674 cc (26 h.p.) V-twin 4 cycle, liquid cooled
 Transmission: 2 forward speeds, neutral and reverse
 Clutch: Variable speed torque converter
 Fuel Capacity: 27 Litre (5.9 Imp. Ga., 7.1 U.S Gal.)
 Steering/Brakes: Hydraulic Caliper, 10.25" disc with holding brake system
 Drive Chains: Double RC-50 roller chains & Single RC 60 Roller chain
 Electrical: 12 volt D.C. battery, 435 cranking amps at 0 F; 25 Amp charging system, electronic ignition
 Speed: Land - 32 km/hr (20 mph)*
 Water - 4 km/h (2.5 mph)
 Load Capacity: Land - 6 persons or 522kg (1150lbs)
SEE SECT.1.4.1 Water - 4 adults or 454kg (1000lbs)
 Tires: 25x12.00-9NHS, 2 ply
 Dry Weight: 567kg (1250lbs)

8x8 AVENGER 750 EFI (H)

Engine: Kohler 747 cc (31 h.p.) V-twin 4 cycle, liquid cooled
 Transmission: 2 forward speeds, neutral and reverse
 Clutch: Variable speed torque converter
 Fuel Capacity: 27 Litre (5.9 Imp. Ga., 7.1 U.S Gal.)
 Steering/Brakes: Hydraulic Caliper, 10.25" disc with holding brake system
 Drive Chains: Double RC-50 roller chains & Single RC 60 Roller chain
 Electrical: 12 volt D.C. battery, 435 cranking amps at 0 F; 25 Amp charging system, electronic ignition
 Speed: Land - 32 km/hr (20 mph)*
 Water - 4 km/h (2.5 mph)
 Load Capacity: Land - 6 persons or 522kg (1150lbs)
SEE SECT.1.4.1 Water - 4 adults or 454kg (1000lbs)
 Tires: 25x12.00-9NHS, 2 ply
 Dry Weight: 567kg (1250lbs)

8x8 FRONTIER 650 (J)

Engine: Briggs & Stratton Vanguard, 627 cc cooler cleaner running (23 h.p.) V-Twin, 4 cycle, air cooled
 Transmission: 2 forward speeds, neutral and reverse
 Clutch: Variable speed torque converter
 Fuel Capacity: 27 Litre (5.9 Imp. Ga., 7.1 U.S Gal.)
 Steering/Brakes: Hydraulic Caliper, 10.25" disc with holding brake system
 Drive Chains: Double RC-50 roller chains & Single RC 60 Roller chain
 Electrical: 12 volt D.C. battery, 435 cranking amps at 0 F; 20/50 Amp magneto type charging system, electronic ignition
 Speed: Land - 30 km/h (19 mph)*
 Water - 4 km/h (2.5 mph)
 Load Capacity: Land - 6 persons or 454 kg (1000 lbs.)
SEE SECT.1.4.1 Water - 4 adults or 408 kg (900 lbs.)
 Tires: 24x10.00-8NHS, 4 ply
 Dry Weight: 476 kg (1050 lbs.)

6x6 FRONTIER 650 (F)

Engine: Briggs & Stratton Vanguard, 627 cc cooler cleaner running (23 h.p.) V-Twin, 4 cycle, air cooled
 Transmission: 2 forward speeds, neutral and reverse
 Clutch: Variable speed torque converter
 Fuel Capacity: 27 Litre (5.9 Imp. Ga., 7.1 U.S Gal.)
 Steering/Brakes: Hydraulic Caliper, 10.25" disc with holding brake system
 Drive Chains: Single RC-60 roller chain
 Electrical: 12 volt D.C. battery, 435 cranking amps at 0 F; 20/50 Amp magneto type charging system, electronic ignition
 Speed: Land - 35 km/h (22 mph)*
 Water - 5 km/h (3.5 mph)
 Load Capacity: Land - 4 persons or 317 kg (700 lbs.)
SEE SECT.1.4.1 Water - 2 adults or 227 kg (500 lbs.)
 Tires: 24x10.00-8NHS, 8 ply
 Dry Weight: 404 kg (890 lbs.)

6x6 FRONTIER 580 (M)

Engine: Briggs & Stratton Vanguard, 570 cc cooler cleaner running (18 h.p.) V-Twin, 4 cycle, air cooled
 Transmission: 2 forward speeds, neutral and reverse
 Clutch: Variable speed torque converter
 Fuel Capacity: 27 Litre (5.9 Imp. Ga., 7.1 U.S Gal.)
 Steering/Brakes: Hydraulic Caliper, 10.25" disc with holding brake system
 Drive Chains: Single RC-60 roller chain
 Electrical: 12 volt D.C. battery, 435 cranking amps at 0 F; 20/50 Amp magneto type charging system, electronic ignition
 Speed: Land - 35 km/h (22 mph)*
 Water - 5 km/h (3.5 mph)
 Load Capacity: Land - 4 persons or 317 kg (700 lbs.)
SEE SECT.1.4.1 Water - 2 adults or 227 kg (500 lbs.)
 Tires: 24x10.00-8NHS, 4 ply
 Dry Weight: 386 kg (850 lbs.)

6x6 FRONTIER 480 (L)

Engine: Briggs & Stratton Vanguard, 480 cc, V-Twin, 4 cycle, air cooled
 Transmission: 2 forward speeds, neutral and reverse
 Clutch: Variable speed torque converter
 Fuel Capacity: 27 Litre (5.9 Imp. Ga., 7.1 U.S Gal.)
 Steering/Brakes: Hydraulic Caliper, 10.25" disc with holding brake system
 Drive Chains: Single RC-60 roller chain
 Electrical: 12 volt D.C. battery, 435 cranking amps at 0 F; 20 Amp magneto type charging system, electronic ignition
 Speed: Land - 35 km/h (22 mph)*
 Water - 5 km/h (3.5 mph)
 Load Capacity: Land - 4 persons or 317 kg (700 lbs.)
SEE SECT.1.4.1 Water - 2 adults or 227 kg (500 lbs.)
 Tires: 24x10.00-8NHS, 4 ply
 Dry Weight: 386 kg (850 lbs.)

* Speed is 20% less with 34-100-3.3 transmission

SECTION 1 GENERAL INFORMATION

1.4.1 Argo Vehicle Capacity

CAUTION

Vehicle capacity includes occupants, cargo, fuel, and all accessories. Capacity for occupants and cargo is reduced by the weight of accessories as shown in the chart below.

Available vehicle capacity must be reduced if your vehicle is equipped with any accessories. Reduce the available capacity by the total weight of accessories fitted to your vehicle.

Accessory On Vehicle	Reduce By			
	On Land		On Water	
Regular Tracks 6x6	135 lbs. (60 kg)		85 lbs. (40 kg)	
Regular Tracks 8x8	175 (80)		110 (50)	
Supertracks 6x6	145 (65)		90 (40)	
Supertracks 8x8	210 (95)		135 (60)	
Rubber Track 8x8	295 (135)		175 (80)	
Rubber Track 6x6	230 (105)		150 (68)	
Winch Kit	50 (23)		50 (23)	
Brush Guard	11 (5)		11 (5)	
Windshield	33 (15)		33 (15)	
Roll Bar 6x6	50 (23)		50 (23)	
ROPS 6x6	130 (60)		SEE WARNING	
ROPS 8x8	140 (64)		140 (64)	
ROPS 8x8 Avenger	155 (70)		155 (70)	
Half Top	16 (7)		16 (7)	
Full Top 8x8	27 (12)		27 (12)	
Full Top 6x6	22 (10)		22 (10)	
Snow Plow	190 (85)		SEE WARNING	
Dump Box	100 (45)		500 (225)	
Rear Bench Seat	34 (15)		34 (15)	

WARNING

Do NOT use an Argo on water when equipped with a snow plow. Do NOT use an Argo 6x6 in water when equipped with a ROPS. The increased weight of the snow plow out front or the top-heavy weight of the ROPS on the 6x6 will make the Argo unstable and could cause the vehicle to capsize, causing injury or drowning to the driver and passengers.

1.5 REAR SEATS - 8 WHEEL MODELS

Argo 8 wheel models are fitted with “quick-release” rear seats.

Removal

1. Grasp the inner edge of the rear seat at both ends.
2. Lift the inner edge of the rear seat upwards until both plastic bumpers are clear of the upper body.
3. Using an upward motion, pull the seat toward the centre of the rear compartment.
4. Remove the seat.

Installation

1. Place the rear seat over the seat mounting holes in the upper body. Insert the large seat washers through the holes.
2. Using downward pressure, slide the seat towards the outside of the vehicle to lock it in place.

SECTION 1 GENERAL INFORMATION

1.6 IDENTIFICATION AND LOCATION OF CONTROLS

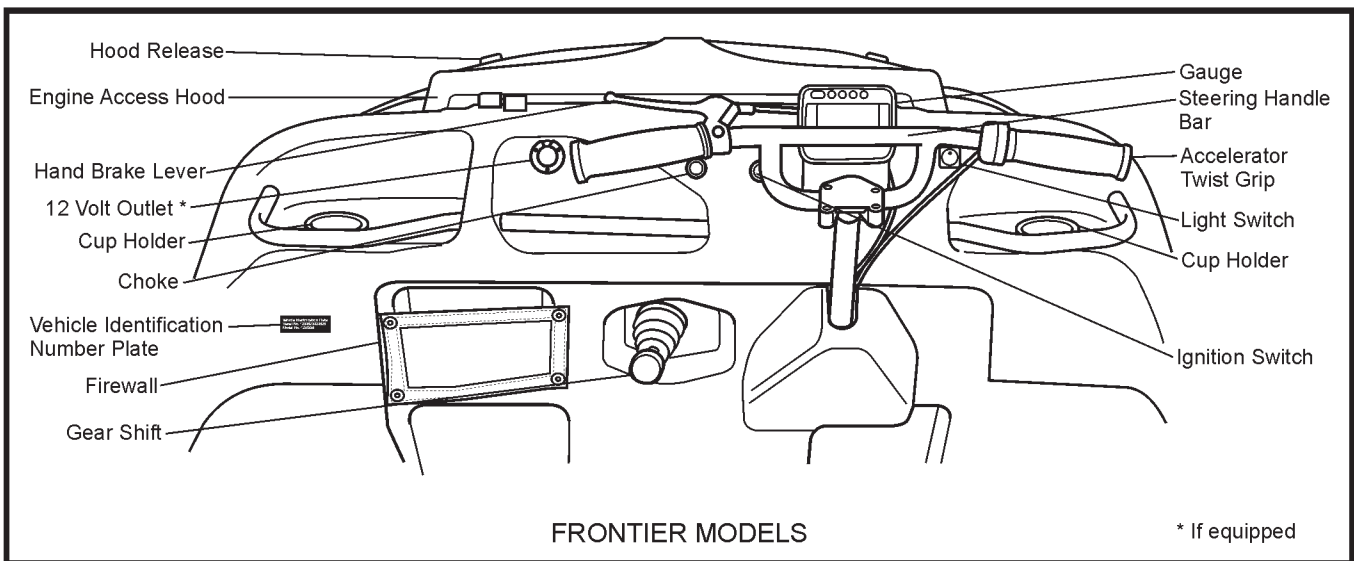
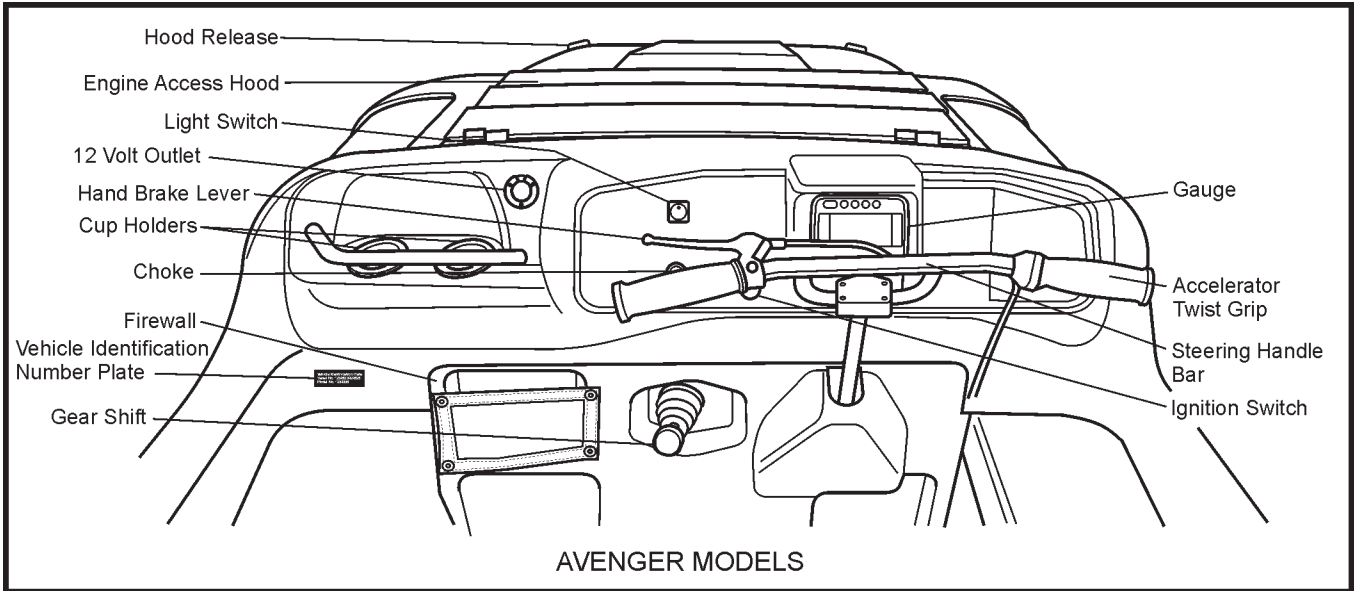

SECTION 1 GENERAL INFORMATION

1.7 INFORMATION LABELS

There are labels on all models which indicate operating hazards and provide special operating instructions. Information about the use of the holding brake system, the use of the vehicle in water, correct fueling procedures and placement of the floorpans has been provided on distinctive coloured labels fastened to the various locations on the Argo.

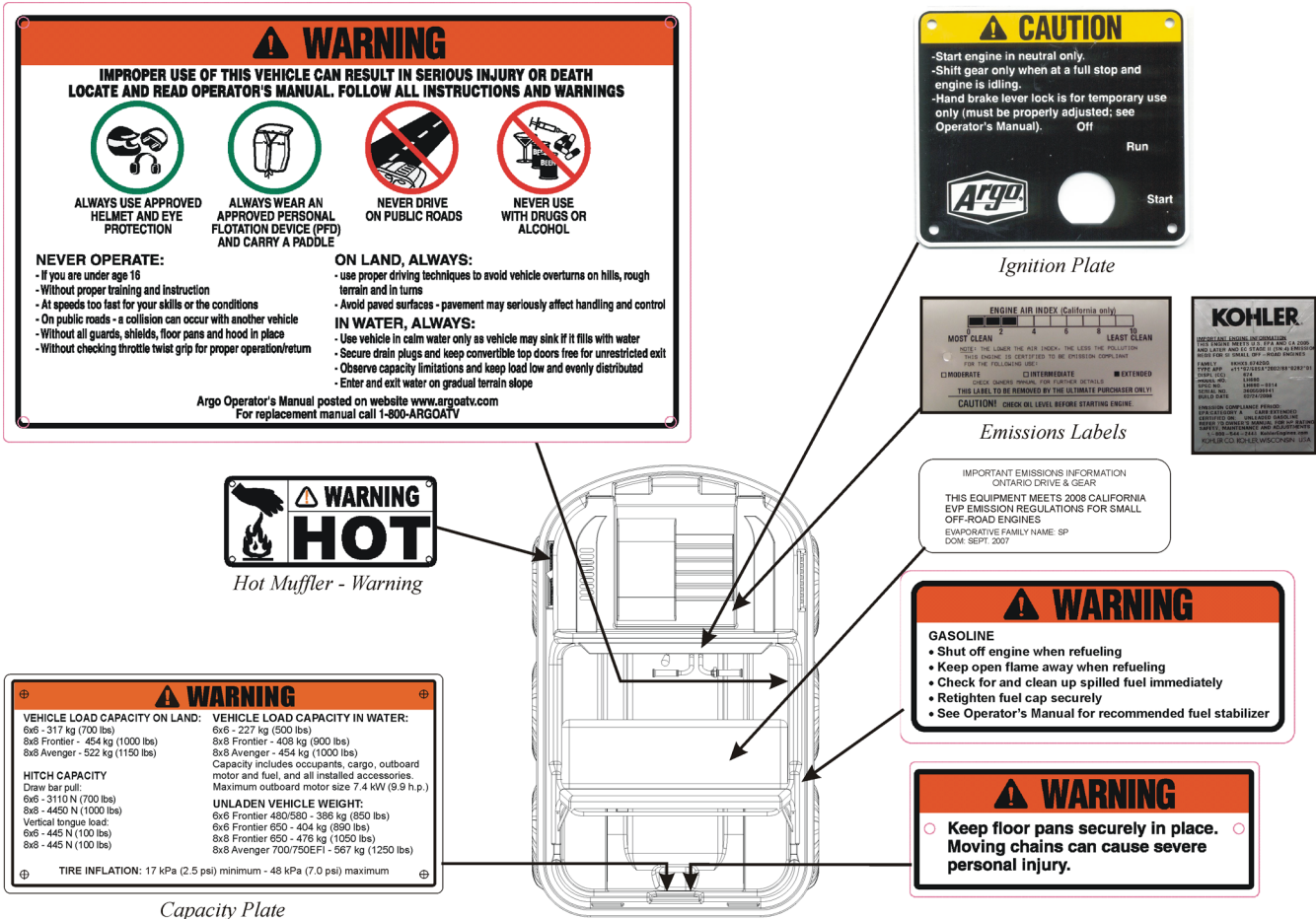

Figure 1-1 Location of Information Labels - All Models

The label shown below is located behind the seat in the rear compartment of all 6-wheel models.

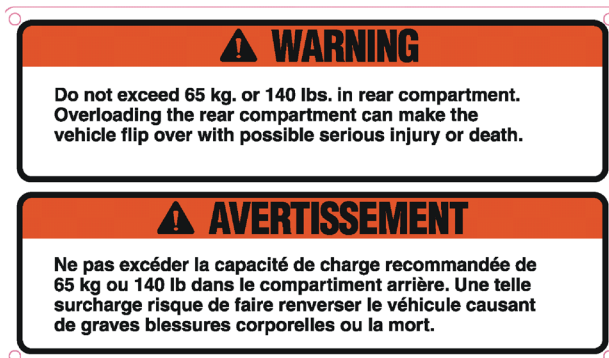

Figure 1-2 Rear Compartment Capacity Label - All 6x6 Models

SECTION 2

GENERAL OPERATING INFORMATION

2.1 NEW VEHICLE “BREAK-IN” PROCEDURE

To obtain long term, trouble free service from your vehicle, observe the following break-in guidelines:

1. Vary the speed of the vehicle for the first tank of fuel. Avoid full throttle operation during break-in period.
2. Check engine and transmission oil levels daily during break-in period.
3. Change the transmission oil after initial 20 hours of operation, or after 2 tanks of fuel have been used. Failure to do so can result in damage to the transmission bearings or gear surfaces. Refer to Section 6.2.2 for transmission oil changing instructions.
4. Change the engine oil in the Vanguard engine after the first 8 hours of operation and in the Kohler engine after the first 20 hours of operation. Refer to Section 6.1.3 of this manual and the oil change section of each engine owner’s manual for oil change information.
5. Check the idler chain adjustment each day before driving the vehicle, and after the initial 2 hours of operation. Refer to Section 7.2.5 for idler chain inspection and adjustment information.
6. Never overload your vehicle. Trying to steer an overloaded vehicle can overheat the brakes. This will lead to brake fade which means loss of steering control and the ability to stop the vehicle. Overloading the vehicle can lead to premature brake system failures and costly damage to drive chains, axles or bearings. Follow the recommended load capacity for the vehicle listed in Section 1.4.
7. Do not allow the brakes to drag, particularly during the first 10 hours of operation. To maximize brake pad life, start by making several low speed turns to both sides. Allow the brakes to cool by driving in a straight line. Repeat the low speed turns. Allow the brakes to cool again. This procedure will properly seat the brake pad friction material to the brake disc. The handlebar should be kept centered during straight ahead operation. Dragging the brakes will cause overheating of the brake components and result in brake fade.
8. The axle flange gaskets and bearing extension gaskets have a tendency to settle on new machines which could result in a loosening of the flange and extension bolts. Check and if necessary re-torque the bolts to 30 ft. lbs. (360 in. lbs.) See Section 7.2.8.

2.2 PRE-OPERATION CHECKS

Carefully follow the engine manufacturer’s recommended pre-operation/daily checks as well as the following:

1. Check the fuel level in the see-through tank located under the driver’s seat.
2. Check the air pressure in all tires. NOTE: Improperly inflated tires can cause the vehicle to pull to one side, requiring constant steering correction. See Section 7.2.6 for tire pressure specifications.
3. Test the operation of the twist grip throttle control by turning it to the fully open position and releasing it. The throttle must operate smoothly and return automatically to the fully closed position. Take the vehicle to an ARGO dealer if the twist grip requires adjustment.
4. Check hand operated brake lever on left hand steering bar for braking capability Section 7.3.5. Check steering handle bar travel to the left and to the right for steering capability. See Section 7.3.6 for Plunger Pin Adjustment.
5. Check the engine intake and exhaust screen for obstructions. Clear any debris that has accumulated.

2.3 CARRYING PASSENGERS AND CARGO

1. Keep cargo as low as possible and evenly distributed.
2. Use extreme CAUTION when negotiating inclines with a loaded vehicle. Heavy loads and high loads decrease the stability of the vehicle and may cause it to roll. Be prepared to shift occupant weight and load forward or have passengers get out of the vehicle to climb an incline.
3. Secure cargo to prevent it from shifting while driving.
4. Do not mount any heavy fixtures to the upper body without support to the vehicle frame. The added weight may cause body deformation that could result in the tires rubbing through the body.

WARNING

The rear compartment capacity of all 6 wheel ARGO vehicles is 65 kg (140 lbs.) MAXIMUM. Exceeding this weight limitation will decrease the stability of the vehicle on inclines and increase the possibility of rolling over backwards when climbing a grade. Do NOT exceed this weight in the rear compartment.

SECTION 2

GENERAL OPERATING INFORMATION

⚠ WARNING

Make sure all passengers riding in an ARGO equipped with tracks and ice cleats are informed to keep hands, feet and clothing inside the vehicle, well away from the tracks and ice cleats, while the ARGO is in motion. Serious injury or death could result from getting caught by the ice cleats.

2.4 OPERATORS WITH DISABILITIES

⚠ WARNING

The information below pertains to safety procedures, which, if not followed, can result in personal injury or death or damage to the Argo vehicle.

We advise persons with disabilities who operate Argo vehicles, to take certain precautions in the interest of their own safety. Since the nature of disabilities can vary widely, it is impossible to give complete instructions that apply to every specific case. Therefore, it is the responsibility of the Argo driver to take steps beyond the ones suggested in the following that take the special nature of his/her disability into account in order to operate the vehicle safely.

Please read this Operator's Manual thoroughly BEFORE OPERATING YOUR NEW ARGO VEHICLE.

Equipment

For mobility-impaired drivers, the following additional equipment should be installed in the Argo vehicle:

- roll-over protection
- a special seat assisting the driver in maintaining his/her seating position
- four-point safety harness
- fire extinguisher within reach of the driver

Maximum Payload

Due to the additionally installed equipment, including any other ARGO accessories, the maximum available payload of the vehicle must be reduced accordingly; refer to Section 1 in your ARGO Operator's Manual under Argo Vehicle Capacity. Never exceed the maximum load capacity of the vehicle.

General

Ensure that the on-board fire extinguisher is fully charged at all times and have it inspected on a regular basis by qualified personnel.

We recommend that you do not venture out in your Argo without being accompanied by an able-bodied person to assist you in case you encounter difficulty. If this is not possible, make sure that adequate communications equipment (eg. cell phone, two-way radio) with an independent power supply is on-board and communication lines are open at all times to call for help if necessary. Remember, a simple technical failure could leave you stranded.

If parts of your body are pain insensitive, please take extra care to ensure that your skin does not touch components of the Argo that may be hot. Also, be aware of hot air exhaust outlets and moving parts.

If your vehicle is equipped with an optional wheelchair swing-arm lift, make sure that the lift line and the swing arm are secured. An unsecured lift arm or line could injure bystanders or property and can also result in loss of control over the vehicle if it gets caught while driving.

If your vehicle is equipped with a transfer board, ensure that the board is removed from the body support bracket when not in use and safely stored in a spot convenient to reach.

Water Operation

Carefully read Section 5 of the Operator's Manual covering water operation.

Enter the water from a firm gradual slope. If the water is deep enough for the vehicle to float, unlatch all safety belts and restraining devices, including the operator's. In shallow water be prepared to free yourself from restraining devices quickly. If an emergency arises, you and your passengers may have to leave the vehicle quickly.

If the vehicle is equipped with an optional convertible top assembly, fold the top assembly down to allow for a quick exit in case the vehicle submerges and to reduce the surface exposed to the wind.

Be aware that the weight of the ROPS makes the vehicle more likely to rollover in water than an unmodified vehicle.

We do not recommend the use of your Argo on frozen water surfaces because of the danger of breaking through the ice and the risk of exposure in cold water. (Refer to Section 5 of the Operator's Manual.) If you must cross ice-covered bodies of water, take along an able-bodied person to assist if difficulties are encountered.

SECTION 2

GENERAL OPERATING INFORMATION

Land Operation

When operating the vehicle on land, make sure all occupants including yourself are wearing the seat belts and you are strapped in your seat firmly at all times. Loss of seating position could result in loss of control of the vehicle.

Be constantly aware of the overall height and width of your Argo vehicle equipped with the ROPS. Watch out for low objects, eg. brush, branches, etc. which could strike the ROPS and cause the vehicle to stop abruptly, rollover, or go out of control.

Due to the weight of the ROPS, your vehicle is more likely to rollover on land than a standard Argo vehicle. Ensure passengers and operator remain seated at all times and keep all cargo low and evenly distributed.

Seat belts must be properly adjusted and worn by all occupants at all times EXCEPT when the vehicle is floating in water.

We have provided this information because we want you to enjoy your mobility in the outdoors safely. However, please keep in mind that all the warnings and instructions in the world cannot replace common sense. You've got it – please use it.

2.5 FUELING THE VEHICLE

WARNING

Gasoline is extremely flammable and can explode under certain conditions. Do not add fuel while the engine is running or hot. If fuel is spilled in, on or around the vehicle, wipe it up immediately. Flush out any fuel spilled in the vehicle with water and allow it to drain out through the drain plug holes. Do not smoke when filling the fuel tank.

Use clean, fresh, unleaded gasoline in all models of the ARGO. Minimum 87 octane fuel is recommended.

Leaded gasoline can be used as a substitute fuel. However, if leaded gasoline is used, the engine will require more frequent servicing.

Never use gasoline containing methanol or white gas since engine or fuel system damage could occur.

All Argo models are equipped with a 27 litre (5.9 Imp. Gal, 7.1 U.S. Gal.) "see-thru" polyethelene fuel tank located under the driver's seat. Depending on loading and driving condi-

tions, an ARGO can be driven for 7 to 12 hours on one tank of fuel. Verify your vehicle's actual fuel consumption *before* attempting any long trips. Never travel in remote areas or set out on long trips *without* a full tank of fuel and adequate spare fuel stored in approved watertight fuel containers.

The fuel filler neck and fuel cap are located on the right side of the vehicle behind the driver's seat. Replace the fuel cap if fuel leakage occurs, or if moisture is detected in the fuel. Use ARGO Part No. 126-46 fuel cap.

Never fill the tank to the point where the fuel level rises into the filler neck. If the tank is overfilled, heat may cause the fuel to expand and overflow through the vent.

Portable fuel containers may contain contaminants (dirt, water, etc.) that will cause engine operating problems. Use only clean, approved gasoline containers.

After filling the fuel tank, be sure the fuel cap is replaced securely. Do not drive the vehicle unless the fuel cap is properly in place.

CAUTION

Never use untreated gasoline that has been stored for more than 45 days. Stale gasoline can cause deposits to form in the fuel lines and carburetor. These deposits clog the fuel system and cause engine starting and operating problems.

When storing the ARGO for 45 days or more, use ARGO Part No. 127-77 Fuel Stabilizer to treat fuel in the fuel tank and fuel containers.

2.6 VENTED FUEL SYSTEM - ALL MODELS

All ARGO models have fuel systems that are vented through a special hose connected to the filler neck assembly that runs along the upper body to a fitting at the left rear.

WARNING

When installing the Handrail Kit, Convertible Top Kit or Outboard Motor Bracket; Since the fuel vent hose runs along the under side of the upper body, care must be taken when drilling mounting holes. The fuel vent hose could be pierced during the drilling process, resulting in a dangerous fuel leak into the vehicle and a costly repair procedure.

SECTION 2 GENERAL OPERATING INFORMATION

CAUTION

Never use gasoline or other harsh solvents to clean the Argo body. All Camouflage material is especially vulnerable to damage and peeling if it comes into contact with gasoline. Take precautionary action when refueling to protect the body from any such occurrences.

2.7 INSTRUMENT CLUSTER

Beginning with 2009 model year, Argos are equipped with an LCD instrument cluster. Figure 2-1.

It displays battery voltage, hourmeter, odometer, speedometer, coolant temperature (on Avengers). There are indicator lights for parking brake, low oil pressure, and diagnostic light (on Avenger 750 EFI).

Gauges are calibrated in metric, speed is in km/h and odometer is in km. Pressing the KM/MILE button will switch the speed to mph and the odometer to mi.

To toggle between odometer and hourmeter, press MODE.

The temperature reading on the gauge is as follows:

- 1 bar: <131°F / <55°C
- 2 bars: 132-166°F / 56-74°C
- 3 bars: 167-202°F / 75-94°C
- 4 bars: 203-237°F / 95-114°C
- 5 bars: >237°F / >115°C

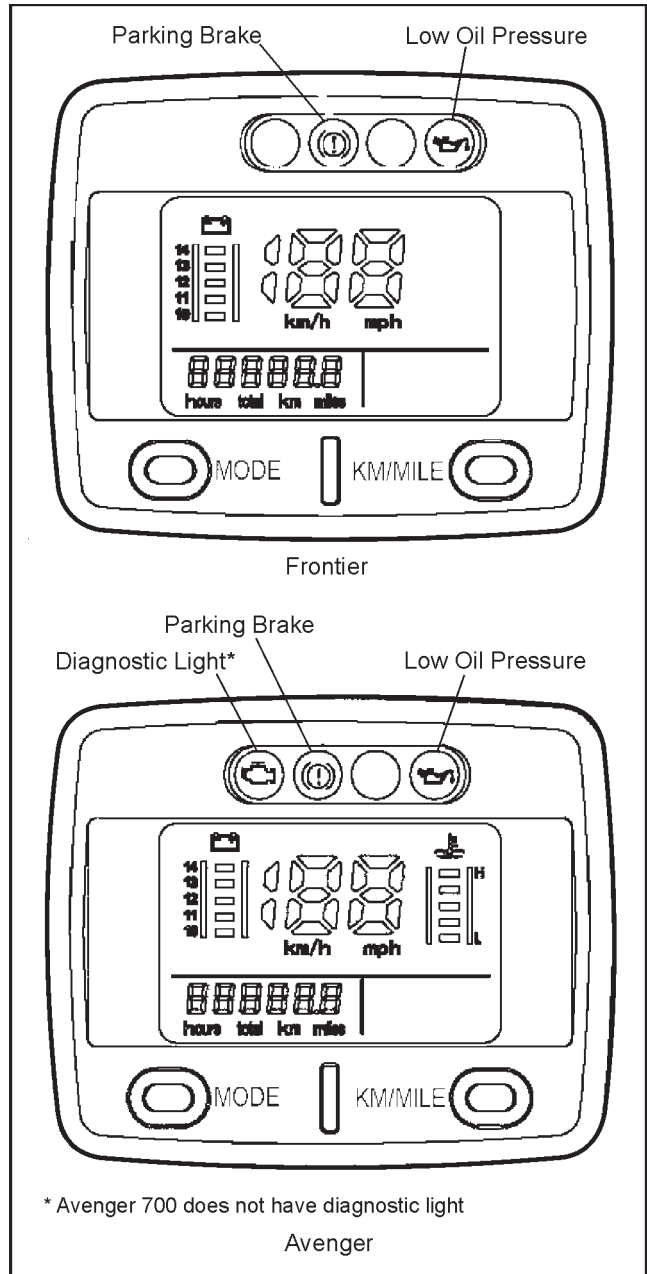

Figure 2-1. LCD Instrument Cluster.

SECTION 3 OPERATING INSTRUCTIONS

3.1 BRAKES AND STEERING

⚠ CAUTION

Do **NOT** oversteer. Avoid the tendency to push or pull harder on the steering system if the vehicle is not responding as expected. Once the vehicle's wheels have been locked, pushing or pulling harder on the steering system will not increase the turning capacity of the vehicle. Damage may occur to the steering system as a result of oversteering.

The moto-cross style steering handle bar is used to turn the vehicle when it is moving in forward or reverse. Pulling back on the right side of the steering handle bar while pushing on the left side of the handle bar, causes the vehicle to turn right. Pulling back on the left side of the steering handle bar while pushing on the right side causes the vehicle to turn left. (Figure 3-1). To stop the vehicle, pull back on the hand brake lever located on the left handle bar.

The ARGO is a skid steer vehicle. During a turn, the rear of the vehicle swings outward as the vehicle pivots on the front tire on the inside of the turn. To make a right hand turn, the rear of the vehicle skids out to the left. To make a left hand turn, the rear of the vehicle skids out to the right.

⚠ WARNING

When turning, the back of the vehicle swings to the opposite direction of the turn. 8-wheel vehicles swing out further than 6-wheelers. Always take care to avoid hitting persons or objects with the rear of the vehicle! Serious injury or death can result!

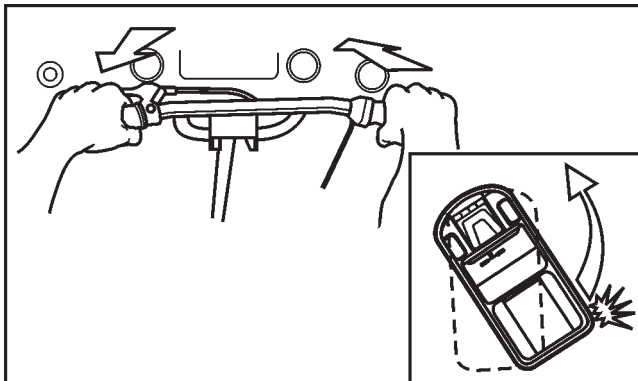

Figure 3-1. Making a left hand turn.

3.2 HOLDING BRAKE SYSTEM

⚠ WARNING

The holding brake system is not a parking brake, and therefore is not designed to hold the vehicle in place for long periods of time. The holding brake is for short term use only.

When parking on an incline, engage the holding brake, leave the vehicle in gear, turn the engine off and block the vehicle's wheels.

When in use, the holding brake system keeps the wheels locked in the full braking position.

To apply the holding brake system:

1. Pull the hand brake lever back and engage the locking pin mechanism by pushing inwards.

To release the holding brake system:

1. Squeeze the hand brake lever to release the locking pin mechanism.

3.3 THROTTLE CONTROL

Vehicle speed is controlled by the throttle twist grip. To increase vehicle speed, turn the twist grip as shown in Figure 3-2. To decrease vehicle speed, release the twist grip so the engine returns to idle.

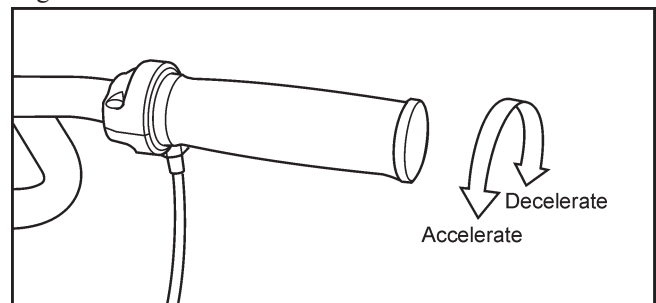

Figure 3-2. Operation of the throttle twist grip

3.4 STARTING PROCEDURE

⚠ WARNING

Never start or run the engine in a closed building or confined area. Engine exhaust gases contain poisonous carbon monoxide. Carbon monoxide is odourless, colourless and can cause serious personal injury or death.

All ARGO models are equipped with key operated, electric start systems. Starting procedure is identical for all models.

SECTION 3

OPERATING INSTRUCTIONS

To start the vehicle, proceed as follows:

1. Place the gearshift in the neutral (N) position.
2. Apply the holding brake system.
3. Use the choke if the engine is cold. Open the accelerator twist grip control 1/8 turn.
4. Turn the key to the "START" position. (See Figure 3-3).

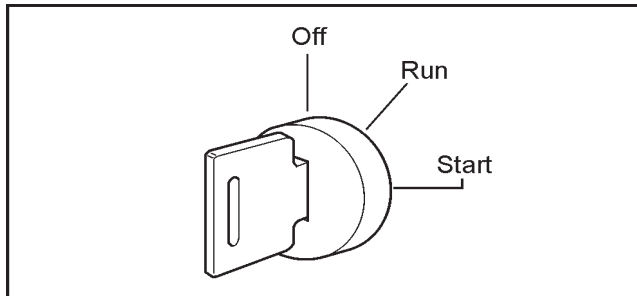

Figure 3-3. Ignition Switch.

CAUTION

Do not operate the starter continuously for more than 5 seconds or the starter may overheat. Wait 30 seconds between each operation of the starter to let it cool and the battery power recover. Never attempt to restart the engine until the engine completely stops. Always remove key from switch when leaving vehicle unattended or when vehicle is not in use.

5. Release the key as soon as the engine starts: the key will automatically return to the "RUN" position.
6. Release the twist grip control and allow the engine to come to an idle.
7. Push the choke in halfway after the engine starts, and push it in all the way as the engine warms up. Release the parking brake.
8. If the engine fails to start, refer to the troubleshooting chart in Section 8 for corrective action.

3.5 NEUTRAL START SWITCH

If the vehicle will not start in neutral, the battery has a charge, and the electrical connections to the neutral start are all ok, find the two green wires labelled "override" and unplug them from the wire harness. (Open the hood and locate them to the right of the fuse block.) Connect the 2 wires that are labelled "override" together. This bypasses the neutral start switch on the transmission. Have the problem corrected by your Argo dealer ASAP. Connect these two wires together and start the unit. **Make sure that the neutral start device is repaired**

and reconnected at the earliest convenience as an accident may occur.

3.6 PRIMING PROCEDURE FOR AVENGER EFI

If the vehicle has run out of fuel, follow the procedure below to prime the fuel system to restart.

1. Turn the key switch to the "ON" position for one minute. Allow the fuel pump to cycle and prime the system. Turn the key switch "OFF".
2. Turn the key switch to the "START" position, crank and start engine.
3. If the engine fails to start, repeat steps 1 and 2. If the engine does not start after two priming intervals, contact your Kohler Engine Service Dealer for further assistance.

3.7 STOPPING THE ENGINE

Release the throttle twist grip. Let the engine speed return to idle and turn ignition switch to the "OFF" position. Always remove key from ignition switch when leaving the vehicle unattended.

3.8 MANUAL STARTING PROCEDURE

FRONTIER models can be manually started using the recoil starter on the Vanguard engine.

1. Turn the key to the "RUN" position.
2. Place the gearshift in the neutral (N) position. Engage the hand lever holding brake and the emergency/parking brakes.
3. Pull out the choke if the engine is cold.
4. Remove the engine compartment hood.
5. Grasp starter grip as illustrated and pull slowly until recoil engages (Figure 3-4).
6. Open the accelerator twist grip control 1/8 turn, then pull cord rapidly to overcome compression, prevent kickback and start engine. Repeat if necessary with choke pushed in slightly.
7. When engine starts, push choke in gradually.
8. Release the parking brake.

SECTION 3 OPERATING INSTRUCTIONS

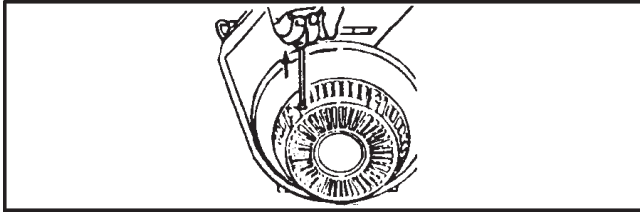

Figure 3-4. Recoil Starter - Vanguard Engine.

NOTE

NO MANUAL STARTING PROCEDURE IS AVAILABLE FOR THE AVENGER.

3.9 SELECTING AND CHANGING TRANSMISSION GEARS

All models are equipped with a four position transmission. The gearshift lever extends through the firewall and is moved in an "H" pattern. Low Range is located to the left of neutral, high range to the right of neutral and reverse up and to the right of neutral. (See Figure 3-5.) PLEASE OBSERVE CAUTIONS.

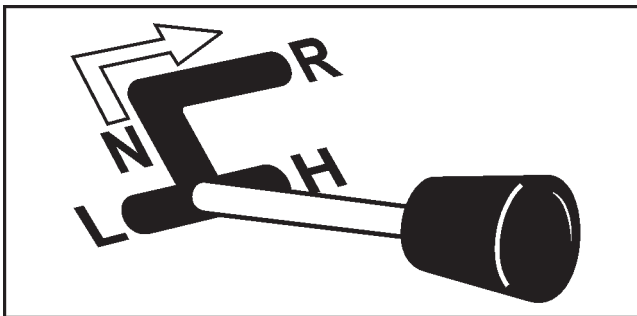

Fig 3-5. Direction of gear shift travel and gear positions.

CAUTION

Do not attempt to move the gearshift from the neutral (N) starting position until the engine idles down completely. The ARGO is equipped with an automatic clutch that is activated by engine speed. If the engine idle speed is too high, the transmission will grind during gear engagement.

3.9.1 Changing Transmission Gears

DO NOT CHANGE TRANSMISSION GEARS WHILE THE VEHICLE IS MOVING. To change gears, bring the vehicle to a complete stop, let the engine idle down completely, engage hand brake and move the shift lever to the selected gear.

3.10 HEADLIGHTS

All ARGO vehicles are equipped with 2 headlights that are operated through the dash mounted light switch. To turn the lights on, push the switch.

CAUTION

Do not leave the lights on for any length of time when the engine is not running. Leaving them on will drain the battery.

Always turn the ignition switch to the 'OFF' position when turning off the engine. On AVENGER models the brake cooling system remains operational in the 'RUN' position after the engine has been turned off.

Avoid frequent starting of the engine and extensive idling. Both will lead to a drain of the battery because the electrical draw is greater than the charging rate at engine idle.

SECTION 4 DRIVING PROCEDURES

4.1 DRIVING STRAIGHT AHEAD

The Moto-Cross style steering bar is spring loaded to return to a centered position. (See Figure 4-1). At this location, no braking is applied to either of the calipers. It is at this position that the steering bar should be when driving straight ahead. Turn the throttle twist grip slowly until the clutch system engages and the vehicle moves forward.

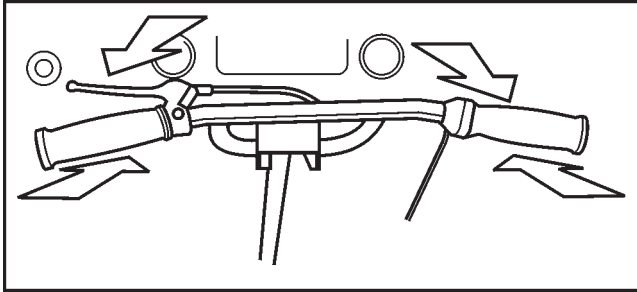

Figure 4-1. Position of moto-cross style steering bar in straight ahead operation.

4.2 STOPPING THE VEHICLE

Allow the throttle grip to return to the idle position. Squeeze the handle mounted brake lever with your left hand.

4.3 TURNING THE VEHICLE

The ARGO is a skid steer vehicle. The rear of the vehicle swings outward during a turn. Always take precautions when making turns to avoid hitting persons or objects. The proper way to make a wide turn is illustrated in Figure 4-2. Make a series of short turns. Centre the steering handle bar. Riding the brakes while making turns will result in excessive heat, brake fade and lead to premature brake wear.

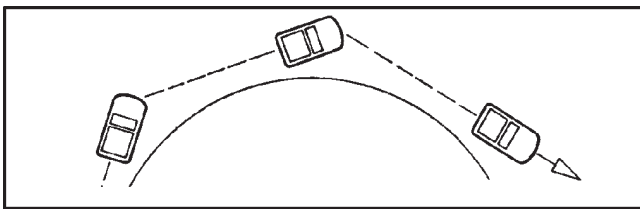

Figure 4-2. Correct method of making a wide turn

⚠ WARNING

Sharp turns, especially at high speeds or when heavily loaded, may cause the vehicle to roll over. Slow the vehicle down before making a turn. Do not apply the brakes too suddenly.

4.3.1 Left Turn

⚠ CAUTION

Do NOT oversteer. Avoid the tendency to push or pull harder on the steering system if the vehicle is not responding as expected. Once the vehicle's wheels have been locked, pushing or pulling harder on the steering system will not increase the turning capacity of the vehicle. Damage may occur to the steering system as a result of oversteering.

To make a left turn, pull back on the left steering bar while at the same time pushing on the right to stop the wheels on the left side of the vehicle. When the turn has been completed, return the steering bar to the centre position.

4.3.2 Right Turn

Pull back on the right steering bar while at the same time pushing on the left to stop the wheels on the right side of the vehicle. When the turn has been completed, return the steering bar to the centre position.

4.4 BACKING THE VEHICLE UP

With the engine at idle, shift the transmission into reverse. Ensure that the steering handle bar is centred. Turn the throttle twist grip slowly until the clutch engages and the vehicle moves backwards. Increase speed by gradually turning the accelerator twist grip.

4.4.1 Turning The Vehicle While Backing Up

Pull on the right bar and push on the left to turn right. Pull on the left bar and push on the right to turn left. When turning the vehicle while backing up, the rear of the vehicle swings in the direction of the turn. This is unusual for most people who are not familiar with skid steer vehicles. Carefully practice backing up and turning in an open area until you become accustomed to this procedure. Take precautions to avoid hitting persons or objects.

⚠ WARNING

Do not push against the firewall with your knees. Damage to the firewall and serious personal injury can result from the driven clutch wearing through the firewall.

SECTION 5

DRIVING PROCEDURES IN UNUSUAL CONDITIONS

5.1 REMOTE AREA USE

When traveling in remote areas or when traveling long distances, the following items are essential:

- a first aid kit
- a complete survival kit
- protective clothing and footwear
- waterproof safety matches
- candles
- emergency flares
- communications equipment
- adequate fuel supply in approved, watertight containers
- fire extinguisher
- back-up battery
- basic mechanic's tools and Argo spare parts

Before venturing into remote areas, carry out all inspections, adjustments and lubrication checks detailed in this manual. Do not proceed unless your vehicle is in good working condition.

Inform someone of your departure and return plans and your route so that help can be dispatched if you do not return as scheduled. Do not travel into a remote area alone.

Choose your equipment and supplies to meet the climate and terrain conditions that you may encounter.

Practice safe driving habits when traveling in remote areas. Avoid terrain that may be impassable.

5.2 ANGLE OF OPERATION

When operating any Argo vehicle on an angle, (up and down hills or across uneven terrain that causes the vehicle to tilt in any direction) the engine oil level and fuel delivery to the engine is affected.

If the engine oil level falls below the oil pump intake, damage can occur because of inadequate lubrication. To avoid engine damage and costly repairs:

- Do not operate your engine continuously on angles or inclines that are greater than 30 degrees in any direction.
- Make sure the engine oil level is near the "full" mark (However, do not overfill.)

The engine may also starve for fuel if the angle of operation is excessive. An engine starved for fuel is likely to sputter and hesitate, and may cause the vehicle to "buck." This can lead to loss of control and rollover. To prevent this, do not operate the vehicle on slopes greater than 30 degrees.

5.3 UPHILL OPERATION

WARNING

Never accelerate or brake suddenly while driving up or down a hill. Sudden acceleration or braking can cause the vehicle to roll over, causing serious personal injury or death.

The rear compartment capacity of all 6 wheel ARGO vehicles is 65 kg (140 lbs.) MAXIMUM. Exceeding this weight limitation will decrease the stability of the vehicle on inclines and increase the possibility of rolling over backwards when climbing a grade. Do NOT exceed this weight in the rear compartment.

Never attempt to turn the vehicle around on a steep hill or grade. Turning the vehicle around on a hill can result in the vehicle rolling over.

Approach the hill head on to minimize the possibility of sliding sideways or rolling over. Accelerate slowly to prevent loss of traction. When traction is lost, the vehicle may slide sideways or backwards. If this occurs, apply the brakes gently and evenly to stop the slide. Allow the vehicle to coast to the bottom of the hill by carefully releasing the brakes.

Try to avoid steep hills. When a steep hill can't be avoided, be prepared to shift occupant weight forward, or have them get out of the vehicle to prevent the vehicle from rolling over. As a general rule, driving up a steep hill greatly increases the possibility of rolling over.

5.4 DOWNHILL OPERATION

Always approach the hill head on to minimize the possibility of sliding sideways, or rolling over. Gently apply the brakes to control downward vehicle speed. Do not jam on the brakes while traveling downhill. Sudden braking can cause the vehicle to roll over frontwards.

An alternative to applying the brakes while going down a gentle decline is to use engine braking. Select low range and keep the engine speed up just enough to keep the clutch engaged.

Avoid steep declines when possible. When a steep decline cannot be avoided, shift occupant weight to the rear of the vehicle to prevent the vehicle from rolling over. As a general rule, driving the vehicle down a steep decline greatly increases the possibility of rolling over.

SECTION 5

DRIVING PROCEDURES IN UNUSUAL CONDITIONS

5.5 SIDE SLOPE OPERATION

Do not drive your vehicle across the side of a hill. Side slope operation greatly increases the risk of rolling the vehicle over sideways.

Prolonged side slope operation may cause engine damage. Observe the engine angle of operation limitations in Section 5.2.

Operation on side slopes will require frequent use of the brakes for steering correction since the vehicle tends to head downhill. This may cause brake overheating or fade.

5.6 AMPHIBIOUS OPERATION - GENERAL

⚠ WARNING

ARGO vehicles may sink if they fill with water. If water starts entering the vehicle, head to the nearest shore immediately. Be prepared to abandon the vehicle if it appears that the vehicle will fill with water before you reach the shore. Be especially cautious when operating a loaded vehicle (cargo and/or passengers) in water. Observe the capacity limits.

Use caution and good judgement when entering water. Drowning can occur even in shallow water. Watch for obstacles under the water that could destabilize or upset the vehicle and may cause occupants to be ejected from the vehicle. Make sure all persons in the vehicle are wearing approved life jackets or Personal Flotation Devices.

All ARGO vehicles are self-propelled, amphibious vehicles, capable of navigating calm water, provided the following precautions are observed:

1. Do not enter water if the vehicle is overloaded. Refer to Section 1.4 of this manual for recommended load capacity in water.
2. Do not use seat belts or any restraining device while the ARGO is floating in water. In shallow water, be prepared to free yourself from restraining devices quickly. If an emergency arises, you and your passengers may have to leave the vehicle quickly.
3. Do not attempt to cross large bodies of water. Stay close to the shore in case an emergency arises and you have to leave the water.
4. Do not attempt to navigate any body of water with a strong current. Avoid water operation under windy conditions.

5. Do not use the Argo in water when equipped with tracks unless it is also equipped with an outboard motor. The tracks do not propel the Argo in water.
6. Use extra caution when operating the ARGO in cold water. If the vehicle upsets or swamps, exposure in cold water significantly reduces the chance of survival.
7. Be prepared to adjust the position of cargo and passengers so the vehicle floats level.
8. Care must be taken when encountering submerged obstacles that may upset the vehicle.

Observe the following safety precautions BEFORE entering the water:

1. All occupants must wear an approved personal flotation device (PFD) or life jacket while traveling in water.
2. Equip the vehicle with a paddle and bailing can for water operation. An optional bilge pump kit (ARGO Part No. 638-30) is available from your ARGO dealer and is recommended in addition to the onboard bailing can.

Drain Plugs

3. Drain Plugs are accessible from the outside of the vehicle. Make sure both drain plugs in the rear of the lower body (Figure 5-1) are in place and properly tightened. To install, locate the drain plugs at the rear of the vehicle and thread each drain plug in a clockwise direction into the plug fitting ensuring a snug fit. Check the O-ring on drain plug periodically. When removed, each drain plug remains attached to the hole opening to prevent loss or misplacement of the plug while the vehicle is draining. (Figure 5-2).

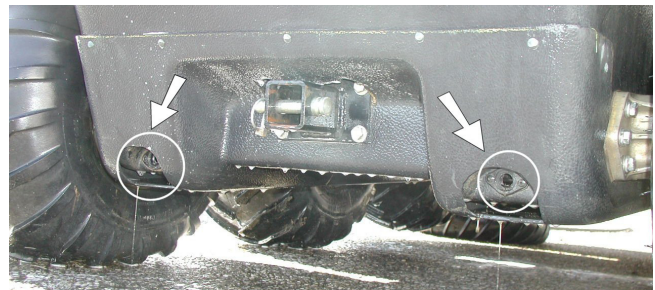

Figure 5-1. Location of rear drain plugs.

4. Visually check the lower body of the vehicle for cuts, punctures or holes that will allow water to enter the vehicle.
5. Make sure that any cargo in the rear of the vehicle is evenly distributed.

SECTION 5

DRIVING PROCEDURES IN UNUSUAL CONDITIONS

- Periodically inspect the outer bearing flange and gaskets of each axle (Figure 5-3) to ensure they are water tight. If there are signs of water leaking into the lower body, take corrective action before entering water again. Make sure there is sufficient grease in the bearing flange and that the grease seal is in good condition.

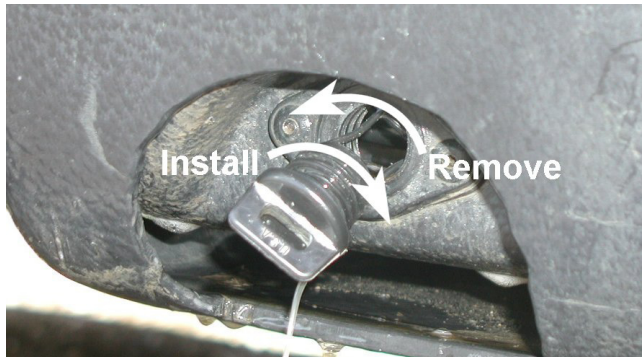

Figure 5-2. Removing and Installing the drain plug.

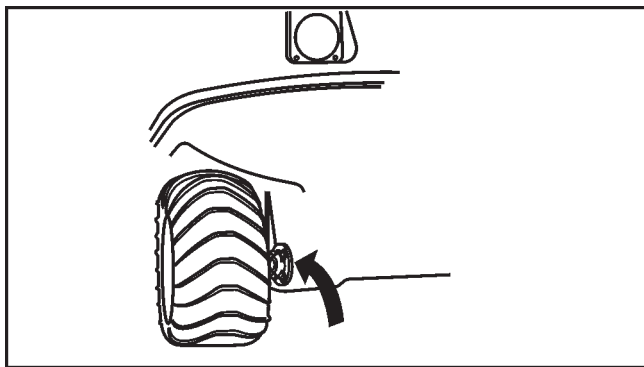

Figure 5-3. Outer bearing flange sealing area.

NOTE

Always observe the recognized rules of boating while traveling in water.

5.6.1 Entering the Water

The point of entry should be free of rocks, stumps and other obstacles. Enter the water from a firm, gradual slope whenever possible. With the wheels partially submerged but still in contact with the bottom, stop and check thoroughly for water entering the lower body.

If a leak is detected, drive back onto shore. Drain the vehicle and repair the leak before re-entering the water.

If the body of water must be entered from a steep slope or uneven terrain, back the vehicle into the water. With the engine and transmission weight concentrated in the front of the

vehicle, the rear is lighter and floats higher.

Be careful not to submerge the bumper as you enter the water. With the bumper submerged, water can enter through the openings in the upper body.

5.6.2 Driving Procedures in Water

After the vehicle is floating evenly on the water, turn the throttle twist grip to increase speed. (**Note: If the vehicle is equipped with a ROPS, unlatch all seatbelts.**) Use only part throttle when traveling through water. Full throttle only results in excessive turbulence, not higher speeds.

The vehicle is steered by a combination of pulling on the right bar and pushing on the left to steer right or vice-versa to travel left. The turning radius is somewhat greater in water, and the vehicle does not respond to changes in direction as quickly as it does on land.

The vehicle is propelled forward through the water by the web of the tires as they rotate. To back up in water, release the throttle, shift the transmission into neutral, and use a paddle.

Avoid rocks, stumps or other obstacles that are below the surface of the water. Striking these obstacles may damage the bottom or upset the vehicle.

If your vehicle begins to fill with water, immediately head to the nearest shore. Get the vehicle out of the water and drain it by removing both rear drain plugs. Correct the leak before entering the water again.

CAUTION

Do not leave the vehicle in water for extended periods of time. Water could enter the axle seals and cause damage to the axle bearings.

5.6.3 Driving Out of Water

When driving out of water, choose an area of the shore that is reasonably flat and free of rocks, stumps and other obstacles. Steer the vehicle so that both front wheels reach the shore at the same time. Accelerate slowly until the vehicle is out of the water. If vehicle is equipped with a ROPS system, re-fasten seatbelts.

5.6.4 Outboard Motor Bracket

Your vehicle may be equipped with an optional outboard motor bracket (ARGO Part No. 617-09 or 617-10) to mount an outboard motor up to 9.9 h.p. A long shaft outboard motor is

SECTION 5

DRIVING PROCEDURES IN UNUSUAL CONDITIONS

preferred to prevent cavitation.

Do not mount an outboard motor on the vehicle unless the special bracket is used. Damage to the vehicle will occur if an outboard motor is mounted directly on the vehicle body.

WARNING

Gasoline is extremely flammable and can explode if ignited. Fill outboard motor fuel tanks outside of the vehicle. Wipe up any spilled fuel immediately. Do not carry or store fuel tanks in a vehicle equipped with a cab or convertible top unless adequate ventilation is provided.

5.7 WINTER OPERATION

Follow these precautions when operating the ARGO in winter conditions:

- Equip the vehicle for remote area use, as listed in Section 5.1.
- Keep the battery fully charged and in good condition.
- Use the recommended winter grade of engine oil.
- Do not allow water or snow to accumulate in the vehicle. Snow may melt during operation of the vehicle, collect in the lower body and freeze around the chains and final drive components, immobilizing the vehicle.
- Store the vehicle indoors or under cover.
- Equip your vehicle with snow tracks for travel over deep snow.
- **Steep, snow-covered or icy hills may be more difficult to ascend. Ice cleat kits (625-20 for 6 wheel or 825-21 for 8 wheel) are available for Super Track systems.**
- Never travel alone into a remote area. Leave your route and arrival plans with someone who can send help if you fail to arrive as planned.

5.7.1 Use on Ice Covered Bodies of Water

WARNING

Using the ARGO on ice-covered bodies of water is potentially hazardous. Use extreme caution. Exposure to cold water reduces a person's chance of survival. Protective clothing, such as a marine survival suit will significantly decrease the effect of exposure in frigid water.

Before venturing out onto ice-covered bodies of water, it is extremely important to:

- Check the ice thickness and condition to be sure it will support the vehicle.
- Take all precautions as in Section 5.6, particularly paragraph 3 referring to drain plugs.

If the vehicle breaks through the ice, it will float in the water, provided that there are no leaks in the body, the drain plugs are in place and vehicle is not taking on water through any body openings. However, there is a risk of the vehicle tipping, particularly if the load is unbalanced. Be prepared to shift occupants' weight for balance.

Getting back onto safe ice depends on various conditions and the expertise of the driver. Be especially careful to prevent water from entering the vehicle.

- Balance the cargo and passenger load.
- Keep openings, like air intakes/exhaust, etc. above the water line.
- Keep the bilge pump running.
- Winch the vehicle out.
- Back onto ice, as the back end is lighter and floats higher in the water.
- Avoid getting the wheels on only one side onto the ice surface as water could enter over the opposite side of the vehicle.
- Avoid turning as the Argo is climbing out to avoid vehicle tip-over.
- Break the thin ice around the vehicle with the paddle until there is firm ice for the vehicle to climb onto.
- Be wary of currents which may pull the vehicle under the ice.

If you feel that you may not be able to get the vehicle back onto safe ice or land, you might consider staying put to await rescue. This may be safer than trying to leave the vehicle to walk over thin ice.

SECTION 6

OIL, FILTER AND LUBRICATION INFORMATION

6.1 ENGINE OIL INFORMATION

⚠ WARNING

Detailed information on standard workshop and safety procedures and general installation practices is not included here. ODG assumes no responsibility or liability for **PERSONAL INJURY** or **VEHICLE DAMAGE** which results from any procedure performed, including those procedures outlined here. Before performing any procedure, an individual must have determined to his/her satisfaction that personal injury or vehicle damage will not result from the procedure, working environment or tools selected.

6.1.1 Checking the Engine Oil Level

Check the engine oil level each day before operating the engine.

To check the oil during an operating period, shut the engine off, let it cool down and allow the oil time to drain into the sump before checking the oil level. Position the vehicle so the engine is level.

The BRIGGS & STRATTON VANGUARD (Figure 6-1) and Kohler engines (Figure 6-2) are equipped with a dipstick and a separate oil filler tube. To check the oil level, clean the area around the dipstick before removing. Remove the dipstick and wipe it with a clean cloth. Re-insert the dipstick and push it all the way into the tube. Remove the dipstick and check the oil level. The oil level should be between the marks. If the level has dropped, add oil to bring the level up to the FULL mark. **DO NOT OVERFILL.**

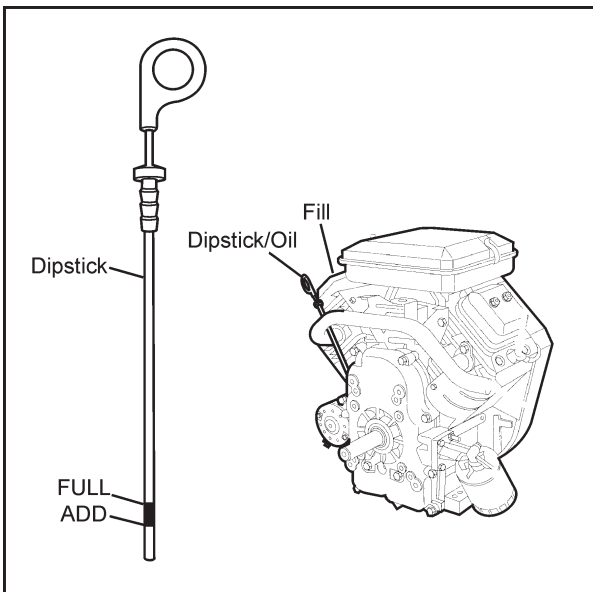

Figure 6-1. Oil fill and level location BRIGGS & STRATTON engine.

⚠ CAUTION

Do not run the engine if the oil level is above the FULL mark or below the ADD mark. Premature engine damage or total engine failure can occur when the oil level is not properly maintained.

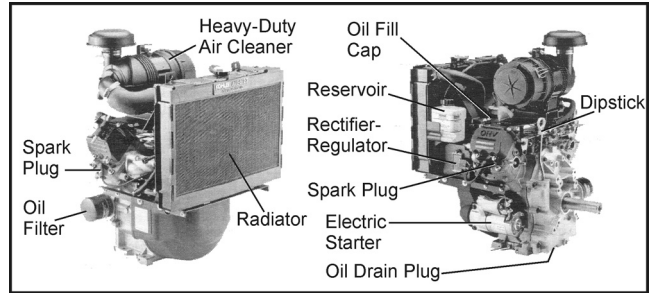

Figure 6-2. Oil fill and level location Kohler Aegis engine.

6.1.2 Recommended Engine Oil

Use a high quality detergent oil of API (American Petroleum Institute) service class as listed in chart. Choose the correct viscosity of oil for seasonal driving conditions. Using the proper type and weight of oil in the crankcase is extremely important. So is checking oil daily and changing oil regularly. Failure to use the correct oil, or using dirty oil, causes premature engine wear and failure.

Viscosity Table - Kohler Aegis Engine

RECOMMENDED SAE VISCOSITY GRADES										
**	10W-30									*
←		5W-20, 5W-30							→	
*F	-20	0	20	32	40	60	80	100		
*C	-30	-20	-10	0	10	20	30	40		
TEMPERATURE RANGE EXPECTED BEFORE NEXT OIL CHANGE										
<p>*Use of synthetic oil having 5W-20 or 5W-30 rating is acceptable, up to 4°C (40°F).</p> <p>**Synthetic oils will provide better starting in extreme cold below -23°C (-10°F).</p>										



SECTION 6

OIL, FILTER AND LUBRICATION INFORMATION

Briggs & Stratton API Service Class SE, SF or SG

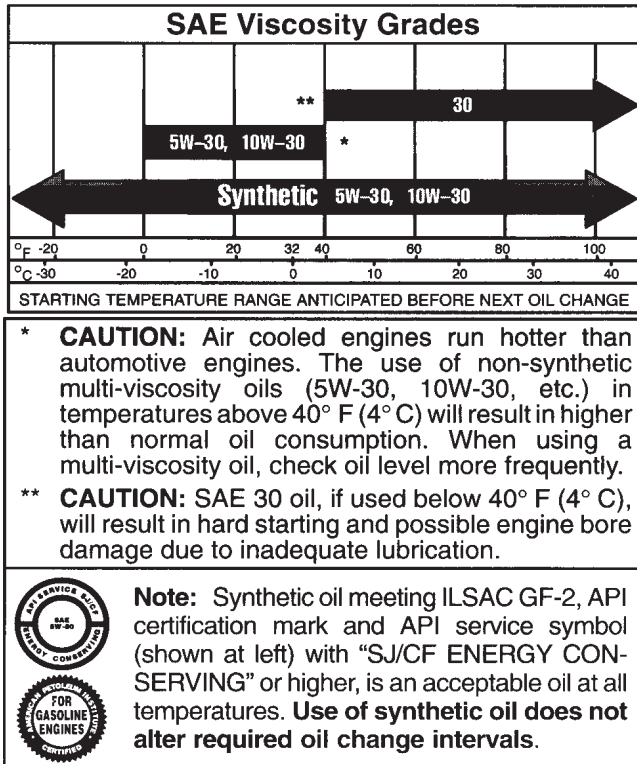

Oil Capacity (with filter)	
Avengers	Frontiers
Kohler	Briggs & Stratton
2.0 qts. 1.9 L	1.7 qts 1.6 L

Figure 6-3. Oil Capacities.

6.1.3 Changing Engine Oil

During the initial engine break-in period, change the oil after the first 8 hours of operation for the Briggs & Stratton engine and the first 20 hours of operation for the Kohler Aegis engine. After the break-in period, change the engine oil every 50 operating hours, or more frequently if the vehicle is operated in dusty or dirty conditions.

Draining the Engine Oil

Each engine is equipped with a drain plug for draining the oil. The drain plug location is shown in the engine owner's manual. Drain the oil from the engine as follows:

1. Start and warm up the engine so the oil will drain easily.
2. Level the vehicle so the oil will drain completely.
3. Place a suitable container under oil drain of engine and

remove drain plug with a wrench: an 8 point 7/16" square socket for Briggs & Stratton engines or a 5/16" Allen socket for Kohler engines.

NOTE

There is limited space between the engine and power pack frame. Cut down an empty plastic container to the correct height so it will fit under the engine oil drain. Make sure the container will hold the amount of oil in the engine.

A ziploc plastic bag makes a convenient oil container. It conforms to the space available and can be closed securely when the oil is drained, then lifted neatly out of the engine compartment.

PLEASE DISPOSE OF WASTE OIL PROPERLY TO CONSERVE OUR ENVIRONMENT.

4. When all the oil has been drained from the engine, clean and replace the drain plug. **MAKE SURE** it is properly tightened before refilling the engine.
5. See Oil Filter Replacement in Section 6.3.3.

Refilling the Engine

Refill the engine through the oil fill port with the correct amount of oil (Figure 6-3). Make sure the appropriate grade of oil is used (Section 6.1.2). As you add oil, frequently check the level with the dipstick. Do not overfill. Start engine. Check for leaks. Stop the engine. Check the oil level. Add oil only to the "Full" mark on the dipstick.

6.2 TRANSMISSION OIL INFORMATION

6.2.1 Checking the Transmission Oil Level

Check the transmission oil level every 50 operating hours. All models of the ARGO are equipped with a transmission oil dipstick (Figure 6-4). Clean the area around the dipstick before removing. Remove the dipstick by pulling up.

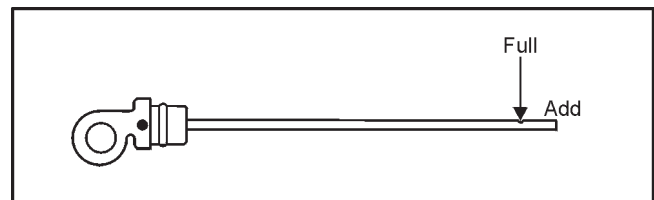

Figure 6-4. Transmission dipstick.

The transmission oil level should be even with the mark on the dipstick as shown in Figure 6-4. Add 80 W 90 Gear Lube HYPOY-C through the transmission oil fill/dipstick hole until the transmission is filled to the correct level. **DO NOT**

SECTION 6

OIL, FILTER AND LUBRICATION INFORMATION

OVERFILL. Replace the dipstick securely.

6.2.2 Changing the Transmission Oil

Change the transmission oil after the first 20 hours of operation, or after using 2 tanks of fuel. After this, change the transmission oil every 100 operating hours. Remove firewall to access the drain plug located at the bottom of the transmission. Drain the transmission oil into a suitable container and dispose of the oil at a disposal site.

While draining the transmission oil, be sure to clean off any metal particles that are on the magnet of the drain plug. These fine metal particles are a result of the transmission gears meshing during the initial break-in period. Re-install the plug and tighten it securely.

Refilling the Transmission

Refill the transmission through the oil fill/dipstick hole. Oil capacity for all transmissions is 38.7 oz.(1.1 L) of 80 W 90 Gear Lube HYPOY-C. As you refill the transmission, check the oil level with the dipstick. Check that the oil level is even with the mark on the dipstick, after it has been seated fully in the dipstick hole. **DO NOT OVERFILL.**

Overfilling may result in oil being forced out the breather hole that could contaminate the brake pads and lead to brake failure.

6.3 FILTER INFORMATION

6.3.1 Air Filter

All Briggs and Stratton engines are equipped with a foam precleaner and dry paper air filter element housed in an air cleaner assembly attached to the carburetor.

Wash and oil the precleaner after every 25 hours of operation or more often under extremely dusty or dirty conditions.

Check the paper air filter element every 100 hours of operation or more often under extremely dusty or dirty conditions.

AVENGER Models

The Kohler Aegis engine is equipped with a heavy duty high density paper air cleaner element surrounding a canister style inner element. Cleaning is not recommended, each element should be replaced when dirty. See Figure 6-5.

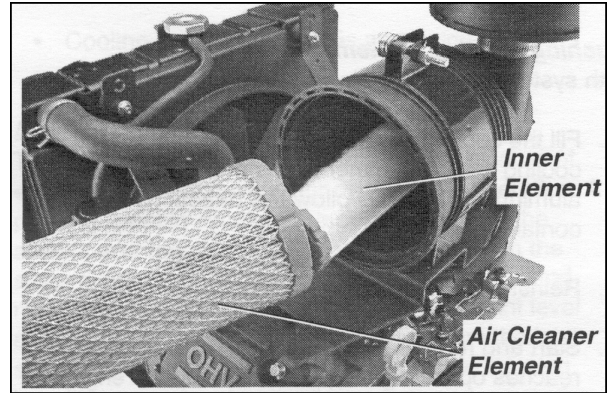

Figure 6-5. Air Cleaner Element and Inner Element.

For instructions to remove, clean and replace the air filter components, refer to the air cleaner section of the engine Owner's Manual.

6.3.2 Fuel Filter

All models of the ARGO are equipped with an in-line fuel filter. Avenger EFI models have 2 fuel filters, located in the rear compartment at the fuel tank (Part Nos. 608-71 & 24 050 03). Figure 6-6. On all other Argo models the fuel filter is located at the engine (ARGO Part No. 125-64).

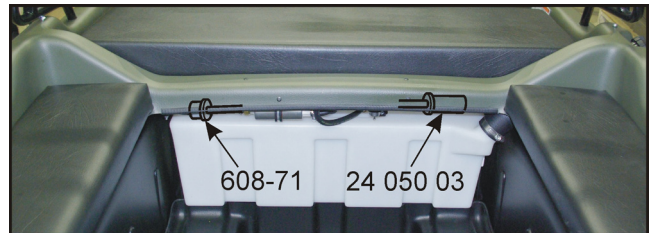

Figure 6-6. Avenger EFI fuel filter locations.

Replace the fuel filter after every 250 hours of operation or once a year. To replace the filter, loosen the gear clamps with a standard screw driver and pull the rubber fuel lines off of the filter. Install the new filter with the flow arrow pointing toward the engine. Tighten the clamps securely. Start the engine and check for fuel leaks.

6.3.3 Oil Filter

During the initial engine break-in period, change the oil filter (Part No. 126-95 for Briggs & Stratton engines or Kohler Part No.12 050 01-S for Aegis engines) when the oil is changed. After that, change the oil filter every 50 hours.

Before installing the new filter, lubricate the rubber filter gasket with fresh engine oil. Screw the filter on by hand until the gasket contacts filter adapter. Tighten 1/2 to 3/4 turn more.

SECTION 6

OIL, FILTER AND LUBRICATION INFORMATION

Start and run engine to check for oil leaks. Stop engine and re-check oil level. Add oil if required.

6.4 LUBRICATION INFORMATION

6.4.1 General

The following parts and components require regularly scheduled lubrication to prevent premature wear and replacement.

1. Idler Chain
2. Drive Chains
3. Bearings

Use the recommended lubricants listed in this section and carefully observe the recommended lubrication intervals.

6.4.2 Clutch Lubrication

No lubrication is required for either the driven clutch or driver clutch. They are designed to run dry. If lubricant is used, use of the vehicle will attract dirt and cause damage to the clutch components. Contamination by dust and dirt can cause poor performance.

A complete service of the clutch units is required after every 250 hours of operation. To perform this procedure, the clutches must be disassembled. Special tools are required to disassemble the clutch units. We recommend that you return your vehicle to an ARGO dealer to have the clutch units serviced.

6.4.3 Drive Chain Lubrication

Your ARGO vehicle is equipped with roller chains to each axle. Lubricate the chains every 10 hours with Aerosol Chain Lube (ARGO Part No. 125-86), or more frequently in dirty or wet conditions.

After every 100 hours of operation, remove all the drive chains from the vehicle and clean them thoroughly in a suitable solvent, i.e. degreaser.

⚠ WARNING

Never use gasoline as a cleaning solvent. Gasoline is extremely flammable and can explode if ignited, causing serious personal injury.

Allow the chains to dry thoroughly, re-lubricate generously with ARGO Chain Lube and re-install.

Refer to Section 7.2.3 of this manual for drive chain removal and re-installation instructions.

6.4.4 Idler Chain Lubrication

Prior to '09 models, lubricate the idler chains after 10 hours of operation, and more frequently if the vehicle is operated in dirty or wet conditions (Figure 6-7). Use only ARGO Chain Lube (ARGO Part No. 125-86) to lubricate the idler chains.

When applying the chain lube, protect the brake discs with a rag or simple cardboard shield (Figure 6-8). DO NOT SPRAY CHAIN LUBE ON THE BRAKE DISCS OR PADS. Roll the vehicle so that all of the idler chain is accessible for lubrication.

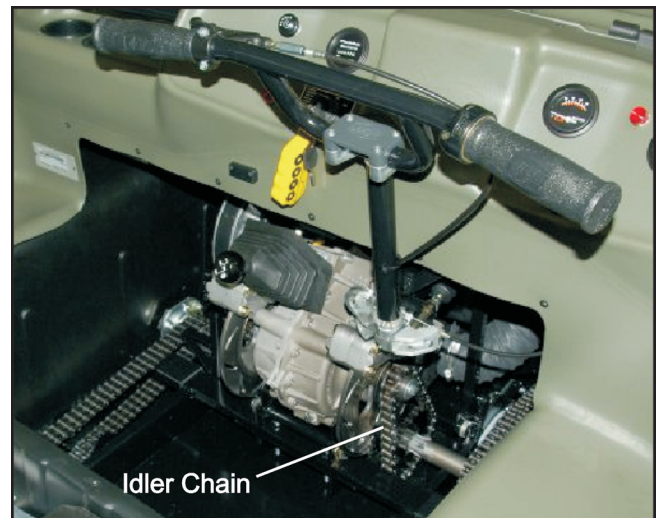

Figure 6-7. Location of the idler chains.

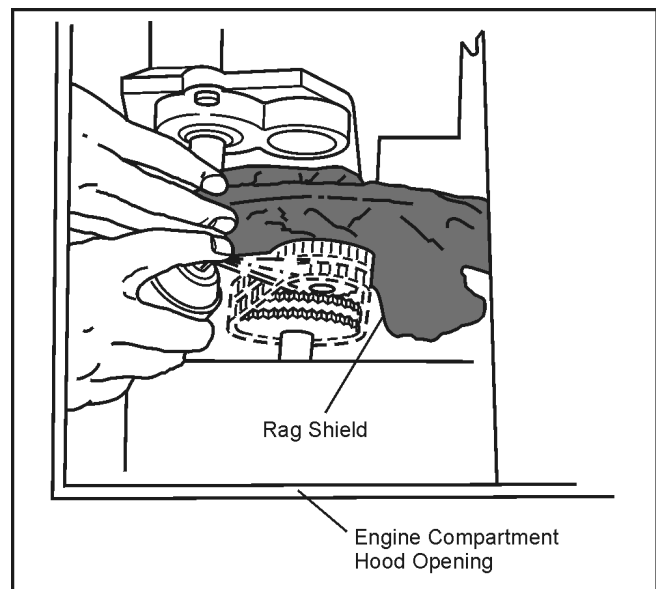

Figure 6-8. Lubricating the idler chain.

Do not use regular oil or grease to lubricate the idler chains. Regular oil or grease will be thrown off the idler chains during normal operation, and contaminate the brake pads or

SECTION 6

OIL, FILTER AND LUBRICATION INFORMATION

discs. When these components become contaminated, brake efficiency is affected.

After every 100 hours of operation, remove both idler chains from the vehicle and clean them thoroughly in a suitable solvent. Allow the idler chains to dry thoroughly, re-lubricate them generously with Argo chain lube and re-install. Refer to section 7.2.5 of this manual for idler chain removal and re-installation instructions.

Starting with 2009 model Argos, maintenance free chains are installed at the idler chain location and do not require frequent lubrication. However, the 100 hour removal, cleaning and relubrication should be done.

6.4.5 Outer Axle Flange & Bearing Lubrication

CAUTION

**DO NOT USE HIGH PRESSURE
PNEUMATIC GREASING EQUIPMENT**

Each outer axle flange is equipped with two grease nipples. Grease the outer cavity through the outer nipple of each flange with a lithium based, NLGI #2 or 3 mineral oil based grease, (such as Shell Alvania #3). Apply at every 25 hours of operation, to flush dirt and water that may have entered the axle seal. Only a small amount of pressure should be required. Grease until any contamination has been forced out past the seal and fresh grease is visible.

At the same time, inspect all the axle seals for damage (Figure 6-9). Vegetation wrapping around the axles can damage the rubber lip of the seal, allowing dirt and water into the outer cavity. Replace any damaged seals.

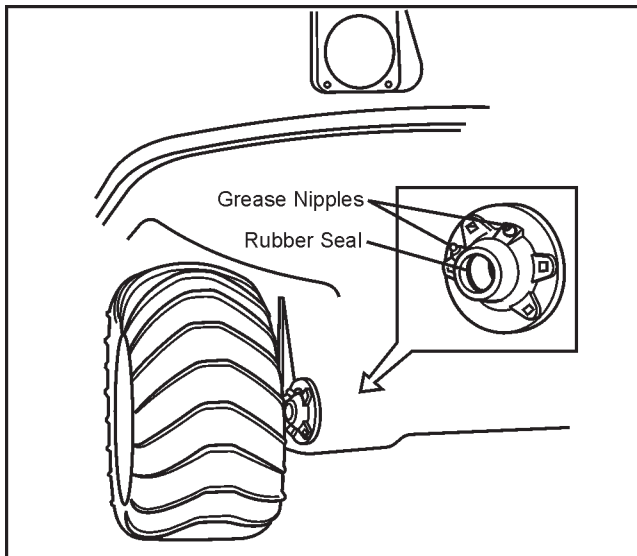

Figure 6-9. Outer Axle Flange.

The second or inner grease fitting of the outer axle flange supplies grease directly to the outer axle bearing. It also requires re-greasing every 25 hours of operation or before the vehicle is taken out of service for any extended period. Use a pistol grip type grease gun to avoid dislocating the bearing seals due to excessive grease pressure.

CAUTION

*Do not use high pressure or excessive amounts of grease.
Damage to the bearing seals could result.*

6.4.6 Idler Shaft Bearing Lubrication

Left and right hand side inner idler shaft bearings are fitted with a right angled grease fitting. With the front floor pan removed, the left side idler shaft grease fitting is accessible at the bottom of the bearing flange. The right side idler shaft grease fitting is located at the top of the flange. Both of these can be accessed conveniently with a grease gun fitted with a flexible extension head. Grease with a small amount of a lithium based, NLGI #2 or 3 mineral oil based grease, (such as Shell Alvania #3). Apply every 100 hours of operation or whenever major maintenance is performed on the vehicle.

6.4.7 Inner Axle Bearing Lubrication

The inner axle flanges are equipped with a grease nipple (Figure 6-10). Lubricate the bearings with a small amount of a lithium based, NLGI #2 or 3 mineral oil based grease, (such as Shell Alvania #3). Apply every 100 hours or before the vehicle is taken out of service for any extended period. Only a small amount of grease is required.

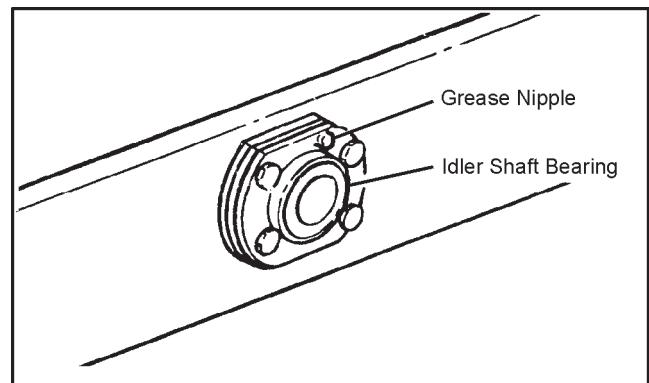

Figure 6-10. Inner axle flange grease nipple.

SECTION 7

MAINTENANCE INFORMATION

7.1 ELECTRICAL SYSTEM

⚠ WARNING

Detailed information on standard workshop and safety procedures and general installation practices is not included here. ODG assumes no responsibility or liability for PERSONAL INJURY or VEHICLE DAMAGE which results from any procedure performed, including those procedures outlined here. Before performing any procedure, an individual must have determined to his/her satisfaction that personal injury or vehicle damage will not result from the procedure, working environment or tools selected.

7.1.1 General

To prevent damage to the electrical system:

- Never weld on the vehicle without first disconnecting both positive and negative battery cables. Make sure the part you are welding is properly grounded.
- Connect battery booster cables properly, positive to positive and negative to negative. Connect negative cable last, disconnect first. **It is not a recommended practice to boost your argo if the battery is dead. If possible, avoid the use of booster cables from an external battery source. Damage can occur to the engine ignition system.**
- Connect switch terminals properly, especially the ground wire.

7.1.2 Battery - ARGO Part No. 127-54 - Exide Part No. 45-50

⚠ WARNING

Battery fluid contains sulphuric acid. If battery fluid comes in contact with skin or eyes, flush thoroughly with water. If swallowed, call physician or poison control centre immediately. **KEEP AWAY FROM CHILDREN.** Serious personal injury can occur. Always wear rubber gloves and safety glasses when servicing the battery.

Batteries can explode and cause serious personal injury if exposed to flame or sparks. Never smoke while servicing the battery.

The battery is located beneath the drivers bench seat, along side the fuel tank, to the right side of the driver.

Checking the Fluid Level

Check the fluid level every 50 hours of operation. Remove the pod vents and make sure each cell is filled to the fluid level

as shown in Figure 7-1. If the fluid has dropped below the fill well, add distilled water until the cell is filled to correct level. **DO NOT OVERFILL.**

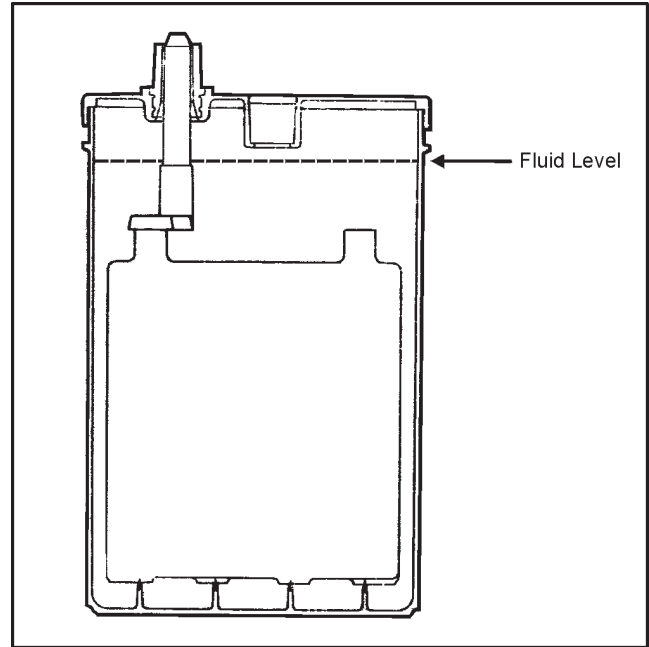

Figure 7-1. Battery fluid level

Charging the Battery

If the battery loses its electrical charge, remove the battery from the ARGO and recharge it with a 12 volt battery charger at the rate of 10-12 amps maximum. The battery should remain on charge until the specific gravity reaches 1.265 on a hydrometer. Re-install the battery in the vehicle and try to start the engine. If the battery fails to perform properly, have it tested by a battery service dealer. Replace a defective battery with ARGO Part No. 127-54/Exide Part No. 45-50.

⚠ WARNING

Ventilate area when charging. Keep away from spark, heat, cigarettes or open flame.

Cleaning the Battery Terminals and Cable Connections

Clean the battery terminals and cable connections every 100 hours. Remove the black NEGATIVE (-) cables first. Make sure you reconnect the NEGATIVE (-) cables to the NEGATIVE (-) post and the red POSITIVE (+) cables to the POSITIVE (+) posts. Damage to the electrical system will occur if the cables are reversed.

SECTION 7

MAINTENANCE INFORMATION

Cleaning the Battery

Clean the top of the battery every 250 hours with a mixture of baking soda and water. Before cleaning the battery, remove it from the vehicle and make sure the pod vents are in place. Soak a cloth in the soda/water mixture and scrub the top of the battery. After the foaming has stopped, flush with clean water and dry with a clean cloth.

7.1.3 ELECTRICAL SYSTEM FUSES

All models of the ARGO are equipped with push-in type automotive fuses. The fuses protect the electrical circuits of the vehicle. They are located in the fuse block, inside the engine compartment, just in front of the steering system. Replace any blown fuses. Return your vehicle to an ARGO dealer for inspection of the electrical circuit if a fuse blows repeatedly.

7.1.4 SPARK PLUGS

Remove and inspect the spark plugs after every 100 hours of operation. Clean the plugs and reset the gap as detailed in the engine owner's manual.

Replace the spark plugs if the electrodes are corroded or damaged or if the insulator is cracked. Use the correct plug for the engine as detailed in the engine owner's manual.

Re-install the spark plugs carefully, taking care to start the threads properly. Torque the plugs to 10 - 15 ft. lbs (14 to 20 N·m). Do not over tighten.

7.1.5 SPARK ARRESTER

Cleaning the Spark Arrester

CAUTION

After operating the engine, do not touch any part of the exhaust system until it has had sufficient time to cool!

1. Keep a record of the number of hours of engine use. The spark arrester should be removed, cleaned and inspected every 50 hours of operation.
2. Remove the tail pipe assembly by disconnecting the springs from the muffler attached to the tail pipe.
3. The screen-type spark arrester assembly is located inside the tail pipe. It is fastened with one (1) slotted washer-head hex screw and one (1) internal tooth lockwasher. Find the screw on the side of the outlet tube.

4. Remove the screw and save it for step 9.
5. The tailpipe and outlet tube are secured together at two (2) welded tabs by one (1) bolt and one (1) locknut. Remove the hardware and separate the tailpipe from the outlet tube.
6. Take out the screen-type spark arrester assembly.
7. Shake loose particles out of the screen assembly.
8. Clean the screen with a wire brush. (Soak it in oil solvent if necessary.)
9. If any breaks in the screen or weldments are discovered, replace the assembly with Part No. 807-67.
10. Return the screen assembly to the tailpipe and outlet tube assembly and re-fasten it with the screw and internal tooth lock washer from Step 4.
11. Secure the tailpipe and outlet tube assembly together with the hardware removed in step 5.

7.2 DRIVE SYSTEM & TIRES

WARNING

Do not attempt to adjust, repair or replace the drive belt, clutches or any moving part while the engine is running. Before servicing the vehicle, disconnect the battery to prevent accidentally starting the engine.

Keep the engine compartment hood, clutch guard and firewall securely in place when the engine is running. Severe injury can result if the drive belt, clutch components or other moving parts come loose.

If engine compartment inspection is necessary while the engine is running, use EXTREME CAUTION! Keep engine RPM low. Avoid standing directly in line with moving components. Use a mirror to view the components.

7.2.1 DRIVE BELT

The drive belt transmits power from the driver clutch (on the engine) to the driven clutch (on the transmission). These components are located on the left side of the engine compartment (Figure 7-2).

SECTION 7

MAINTENANCE INFORMATION

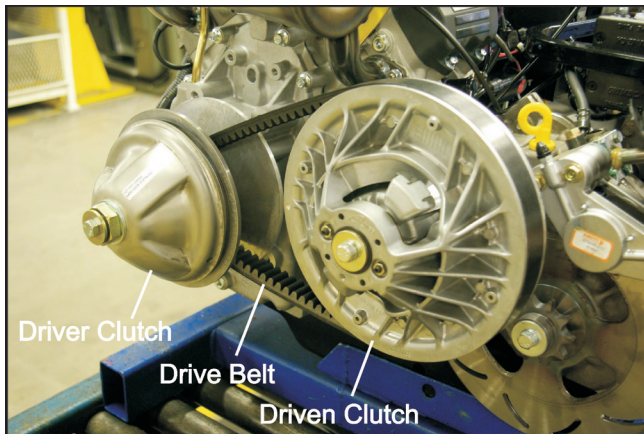

Figure 7-2. Location of drive clutches and drive belt.

Check the drive belt after every 25 hours of operation, or whenever there is a noticeable reduction in clutch performance. Replace the belt when:

- the top width of the belt has worn to 1-1/16" (27mm)
- cracks, fraying or shredding is apparent
- it becomes contaminated with oil or some other fluid

Refer to the ARGO Parts Manual for correct drive belt part number.

To Remove the Drive Belt

1. Make sure ignition is turned off.
2. Remove the engine access hood.
3. Remove the firewall.
4. Place the transmission in N (neutral).
5. Grasping the fixed face of the driven clutch, turn the inside moveable face clockwise forcing the belt down between the 2 sheaves and causing the driven clutch to open. When open far enough to slacken the belt, hold in the spread apart position with one hand while easing the belt over the bottom of the fixed half pulley of the driven clutch and turning the clutch counterclockwise until the belt is off.
6. Remove the belt from the driver clutch.

Alternative Method:

It may be easier to remove both driven and driver clutch from engine and transmission, sliding each off at the same time along with the drive belt.

To install the Drive Belt:

CAUTION

If this procedure is not carried out as described, the edge of the fixed face may cut or damage the drive belt.

1. Position the belt around the driver clutch first.
2. Ease the belt over the edge of the fixed face on the driven clutch and at the same time, turn the inside, movable face clockwise.

Drive Belt alignment and tension are pre-set at the factory and are not adjustable. They are critical for proper operation of the drive system. Return the vehicle to an ARGO dealer if rapid belt wear occurs.

7.2.2 CLUTCH MAINTENANCE

Disassembly and repair of the driver and driven clutch requires special tools. Return the vehicle to an ARGO dealer if the clutch units need servicing. The following indicates that clutch service is required:

- a drop in vehicle performance
- the clutch does not shift smoothly
- the clutch sticks during vehicle operation
- the drive belt wears rapidly
- the vehicle vibrates severely during operation
- the vehicle does not accelerate when the engine speed is increased with the transmission in gear
- transmission will not shift smoothly into gear at engine idle.

Clutch Inspection

Inspect the nylon sliders every 50 hours. The nylon sliders are mounted in the driven clutch moveable pulley. (Figure 7-3). When the clutch shifts, the cam moves on the nylon sliders.

Replace the nylon sliders *before* there is aluminum to aluminum contact between the cam and the movable pulley. Driven clutch disassembly is required to replace the nylon sliders properly. Return the vehicle to an ARGO dealer for service.

SECTION 7 MAINTENANCE INFORMATION

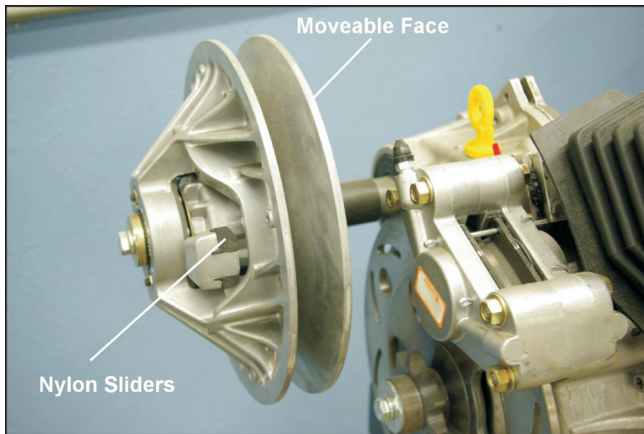

Figure 7-3. Location of the sliders.

7.2.3 DRIVE CHAINS

Roller chain “stretch” results from wear to the chain pins and bushings because of the loss of lubricant.

To prevent sprocket damage and unnecessary breakdowns, replace the chains when:

- the chain tensioner can no longer take up the chain slack.
- the chain is rubbing on a frame cross member.
- the chain is seized due to rust and lack of lubrication.
- the chain climbs the sprocket teeth, especially noticeable when turning.

To remove the Drive Chains:

1. Place the gearshift in the N (neutral) position.
2. Remove the floor pans.
3. Turn the tensioner cam assembly in the direction which winds up the torsion spring and push the assembly down as close as possible to the cam follower block in the bottom of the frame. Secure it in this position with a Vice-Grip 10CR as illustrated in Figure 7-4.
4. Roll the vehicle until the connecting link on one of the chains is visible.
5. Remove the spring clip from the connecting link as shown in Figure 7-5. Remove the outside plate and tap out the connecting link. The inside plates will be released when the connecting link is removed (Figure 7-6).
6. Remove the chain from the vehicle.

7. Repeat steps 4 to 6 until all drive chains are removed.

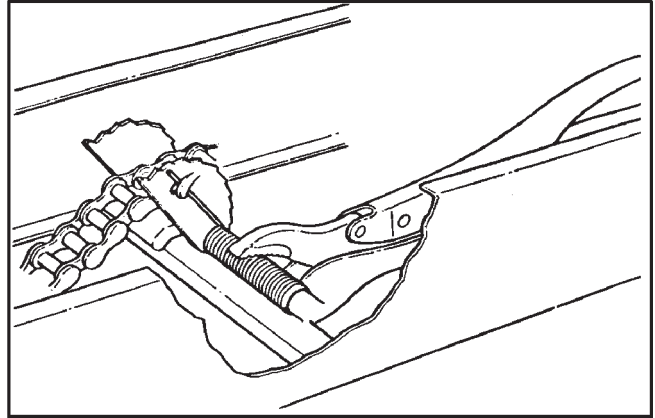

Figure 7-4. Securing tensioner cam

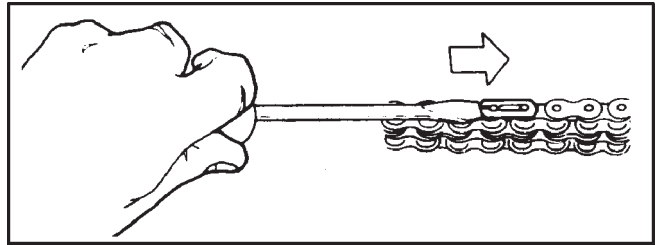

Figure 7-5. Removal of the spring clip.

To install the Drive Chains:

1. Position the drive chain over the slider block and around the drive sprockets.
2. Pull the ends of the chain together and insert the connecting link as shown in Figure 7-6 and 7-7. When connecting the RC50-2 chain, insert the inside plates before tapping the connecting link into position.

NOTE

Use a pair of modified 7R Vice Grips to hold the ends of the chain together while inserting the connecting link. Some drive chains have no slack, and replacement of the connecting link is difficult without this tool. Modified Vice Grips can be ordered from your ARGO dealer (ARGO Part No. 658-08) or refer to Appendix 1 for modification information.

3. Replace the outside plate and spring clip. The open end of the clip must face rearward when it is on top of the chain.
4. Remove the vice-grips securing the cam assembly in its lowest position.
5. Repeat steps 1 to 4 until all chains are replaced.

SECTION 7 MAINTENANCE INFORMATION

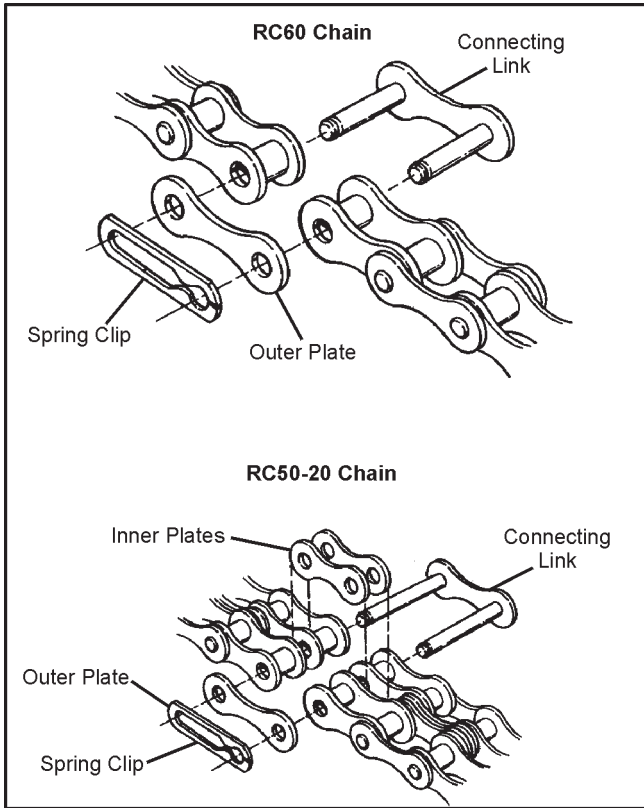

Figure 7-6. Chain connection link components.

7.2.4 DRIVE CHAIN TAKE-UP SYSTEM

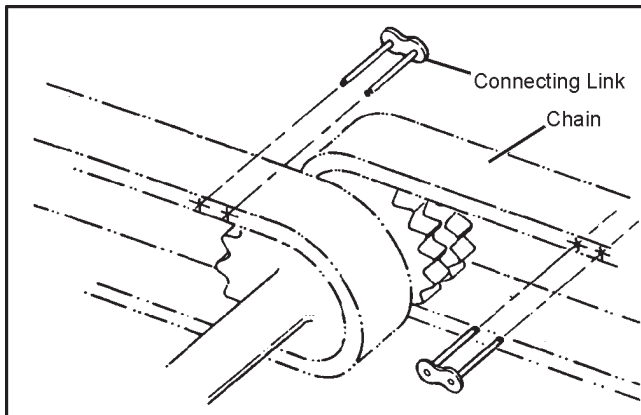

Figure 7-7. Installing the connecting link

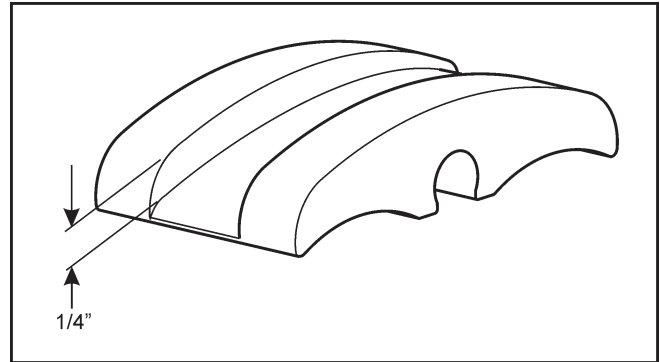

Figure 7-8. Wear groove on the slider block.

The chain tensioning system on all models consists of a torsion spring loaded cam assembly with a slider block which takes up the slack on the bottom side of all but the front final drive chains. As the chain wears, the chain tensioning mechanism adjusts semi-automatically. Under most conditions, the tensioner cam assembly will move to the next step of adjustment simply due to normal drive system dynamics. Sometimes, however, the cam assembly can bind due to debris caught in the area. **IT IS VERY IMPORTANT TO CHECK THAT THE CAM ASSEMBLY IS PROGRESSING PROPERLY. CHECK FOR PROPER CHAIN TENSIONER OPERATION EVERY 10 HOURS OF VEHICLE OPERATION, WHEN THE DRIVE CHAINS ARE BEING LUBRICATED.** Each step of the cam takes up about 3 inches of chain slack (see Fig. 7-9).

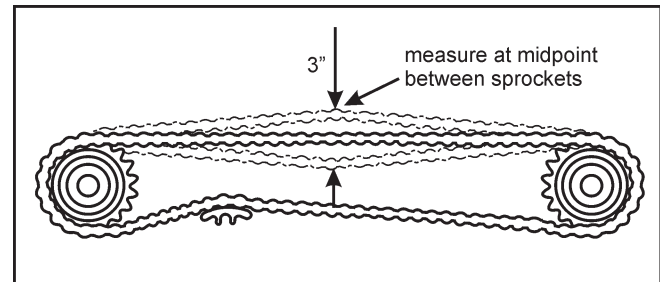

Figure 7-9. Chain slack required before the tensioner will progress to the next step.

The tensioner cannot progress to the next step until there is enough slack in the chain. With the wheels raised off the ground, check if the chain slack exceeds 3 inches. If it does, then reach under the slider block assembly and pull up.

CAUTION

Check for proper chain tensioner operation every 10 hours of vehicle operation.

Each chain tensioner has a single UHMW slider block. Inspect the UHMW slider blocks for wear after the first 100 hours and every 50 hours thereafter. Replace the blocks (ARGO Part

SECTION 7 MAINTENANCE INFORMATION

No. 606-44) when the wear groove, as shown in Figure 7-8, measures 1/4" (6mm).

To Replace a Slider Block:

1. Remove the floor pans.
2. Turn the tensioner cam assembly in the direction which winds up the torsion spring and push the assembly down as close as possible to the cam follower block across the bottom of the frame channels. Clamp it in this position with a Vice-Grip 10CR or similar plier as illustrated in Figure 7-10 and remove the drive chain.
3. With pliers, pry the slider block off the cam assembly as illustrated in Figure 7-10.
4. Place a new slider block over the shaft of the cam assembly.
5. Using a piece of wood (or similar material) pressed against the top of the slider block, carefully hammer the piece of wood so the slider block snaps onto the cam assembly shaft as shown in Figure 7-11.
6. Re-install the drive chain and remove the locking pliers securing the cam assembly in its lowest position.
7. Pull up on the cam assembly to allow it to take up as much chain slack as possible.
8. Replace the floor pans.

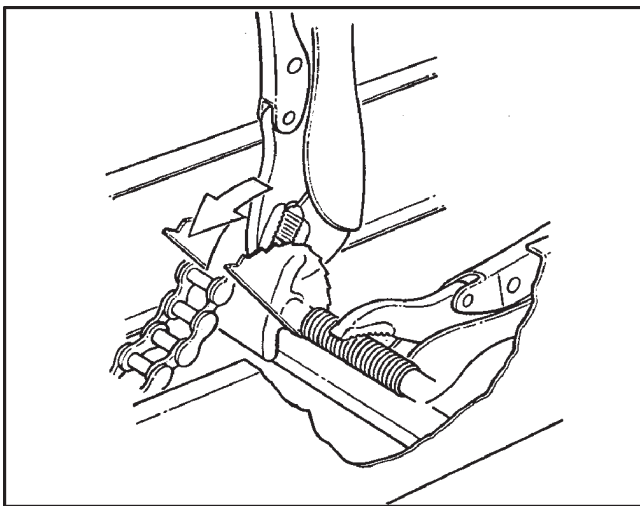

Figure 7-10. Prying the Slider Block off the Cam Assembly.

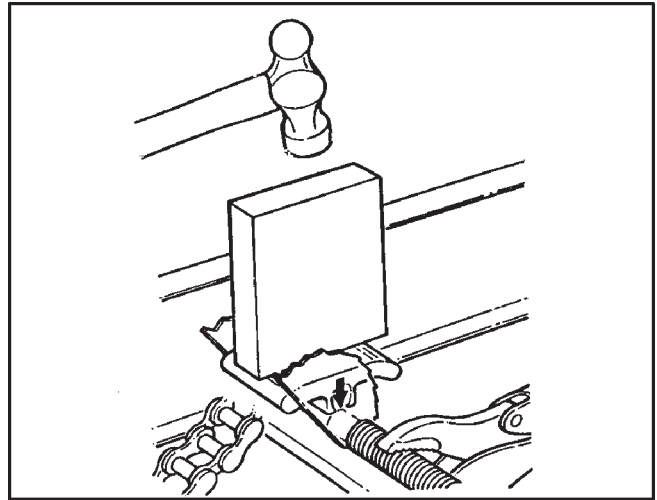

Figure 7-11. Hammering Slider Block into place.

7.2.5 IDLER CHAIN

All ARGO vehicles are equipped with 2 idler chains to transfer power from the output shafts of the transmission to the drive chains through a series of sprockets. They are located on each side of the transmission.

A loose or improperly adjusted idler chain can result in damage to the chain or sprockets. During the new vehicle break-in period, check the idler chain adjustment before operating the vehicle and after the first 2 hours of operation. After the initial break-in period, check the idler chain adjustment every 50 hours. An indication of loose idler chains is a loud banging noise when the vehicle is turned.

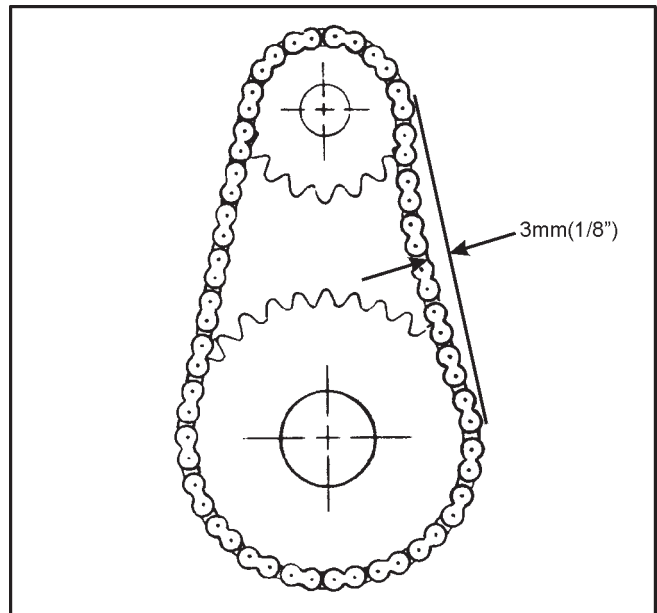

Figure 7-12. Measuring idler chain deflection

SECTION 7 MAINTENANCE INFORMATION

To check the idler chain adjustment, push the slack side of the chain and measure the amount of chain deflection (Figure 7-12). Adjust the idler chain tension if deflection is more than 3mm (1/8").

Idler Chain Adjustment

1. Remove the firewall from the vehicle as detailed in Section 7.3.4.
2. Loosen the 2 left side clamping nuts with a 15/16" socket wrench (figure 7-13).
3. Turn the vertical adjustment bolts counter-clockwise to raise the power pack and tighten the idler chains. The idler chains are properly adjusted when the deflection measures 3 mm (1/8"), (Figure 7-12).
4. Tighten the 2 left side clamping nuts securely. Torque to 80ft./lbs.

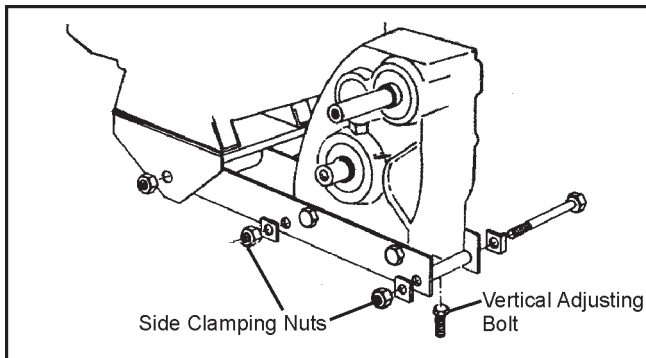

Figure 7-13. Location of power pack clamping nuts and adjusting bolts

To Remove the Idler Chains:

Loosen the power pack clamping nuts and adjusting bolts as shown in Figure 7-13 and proceed as follows:

1. Place the gearshift in neutral and roll the vehicle until the connecting link of one of the idler chains is positioned as shown in Figure 7-14.
2. Remove the spring clip or cotter pins, depending on model, from the connecting link. Remove the outside plate and tap out the connecting link. On models that utilize a double 40 or 50 drive chain, as the connecting link is removed, the inside plates will be released (refer to Figure 7-6). Models with single 60 drive idler chains have no inside plates.
3. Remove the idler chain from the vehicle.
4. Repeat steps 1 to 3 to remove the other idler chain.

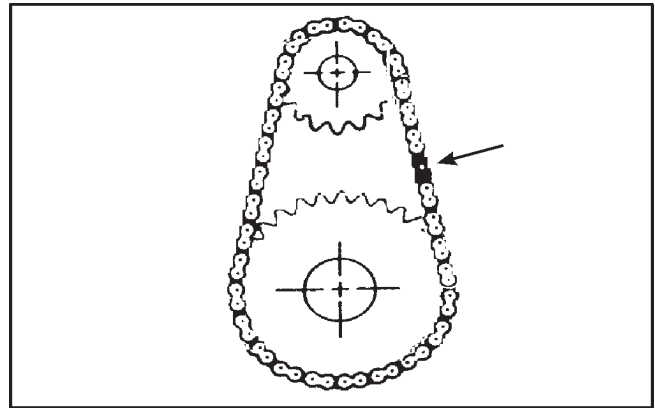

Figure 7-14. Position of idler chain link for removal.

To Install the Idler Chains:

1. Install the chain over the brake disc sprocket and the idler shaft sprocket.
2. Pull the ends of the chains together and insert the connecting link. Insert the inside plates before pushing the connecting link into position (double 40 or 50 chain models only).

NOTE: Use a pair of modified 7R Vice Grips to hold the ends of the chain together while inserting the connecting link. There may be no slack in the idler chain, making installation of the connecting link difficult without this tool. Modified Vice Grips can be ordered from your ARGO dealer (ARGO Part No. 658-08) or refer to Appendix 1 for modification information.

3. Replace the outside plate and spring clip as shown in Figure 7-5. Note: Avenger and Frontier models are secured with two (2) cotter pins. Always use new cotter pins.
4. Repeat steps 1 to 3 to replace the other idler chain.

7.2.6 TIRE INFLATION

Improperly inflated tires can cause the vehicle to pull to one side, requiring constant steering correction. Suggested inflation for the Argo 25x12.00-9, Argo 24x10.00-8, Argo 22x10.00-8 and Argo HEAT 25x12.00-9 is between 2.5 to 3.5 psi (17 to 24 kPa). Maximum operating pressure is 7 psi (48 kPa).

A special low pressure tire gauge (ARGO Part No. 619-10) is available from your ARGO dealer.

SECTION 7 MAINTENANCE INFORMATION

CHANGING TIRE PRESSURE FOR DIFFERENT TERRAIN CONDITIONS

The tire pressure should be adjusted between 2.0 and 7.0 psi according to differences in terrain. Observance of these guidelines will lead to less wear & tear on both vehicle and tires. The operator should equip the vehicle with a low pressure tire gauge (Part No. 619-10) and with a hand pump.

RECOMMENDED GUIDELINES for TERRAIN

Soft Ground:

Low Pressure • On soft terrain, use lower pressure.

Hard Ground:

Higher Pressure • On hard terrain and water, use higher pressure.

Rocky Ground:

Highest Pressure • On rough or rocky terrain, fill to, but not more than the recommended range indicated on the tire sidewall.

This will reduce the possibility of tires and rims being damaged during heavy duty applications.

It is also important to observe the recommended load capacities of your vehicle when travelling on different kinds of terrain. For load capacities of your particular vehicle, see Section 1 of General Information in this operators guide.

IMPORTANT

It is **ultimately the responsibility** of the operator to determine a **SAFE MAXIMUM load capacity in accordance with the driving terrain and conditions.**

7.2.7 TIRE REPAIR AND REPLACEMENT

Repair a flat tire by removing the tire completely from the rim. Proper tire changing equipment is necessary to remove and remount the tire.

Apply a radial tire patch on the inside of the tire over the puncture or hole.

Remount the tire on the rim using a bead lubricant such as Murphy's Tire & Tube Mounting Compound. Spoon the tire onto the rim to prevent tire bead area damage. **THE TIRE MAY EXPLODE IF OVER-INFLATED.** Place the tire and rim assembly in a protective cage to inflate and to seat the beads. Never inflate over 32 psi (220 kPa) to seat the bead. Once both beads are seated, deflate to 2.5 to 3.5 psi (17 to 24 kPa), 7 psi (48 kPa) maximum operating pressure. A special,

low pressure tire gauge (ARGO Part No. 619-10) is available from your ARGO dealer.

Replace badly worn or damaged tires with original equipment Argo tires. Consult your ARGO dealer if in doubt. Any other tires (size, type or tread pattern), will affect the skid steering characteristics of the vehicle.

ARGO track systems are designed for use **ONLY** with original equipment Goodyear Runamuk or Carlisle tires.

7.2.8 AXLE BEARING MOUNTING

The axles are mounted to the Argo using special cork gaskets between the flanged bearings and the outside surface of the lower body (see Figure 7-15). During the initial run-in period, the gasket material may relax causing the nuts to loosen slightly. These should be checked and re-tightened after initial 8 hours of use and then after every 100 hours. See Figure 7-16.

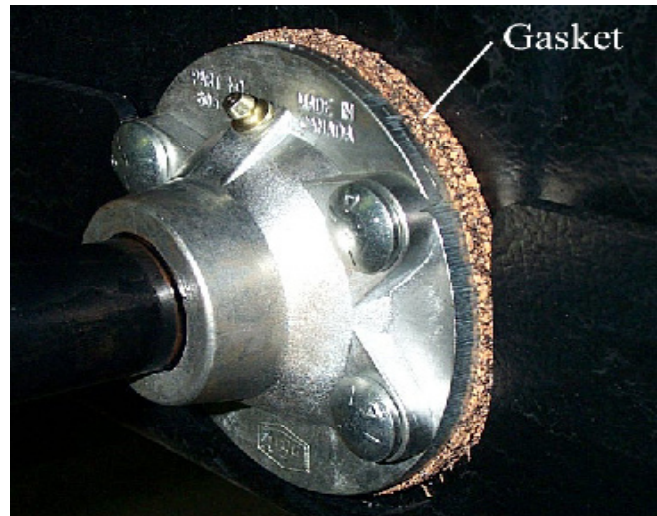

Figure 7-15. Bearing Flange and Cork Gasket

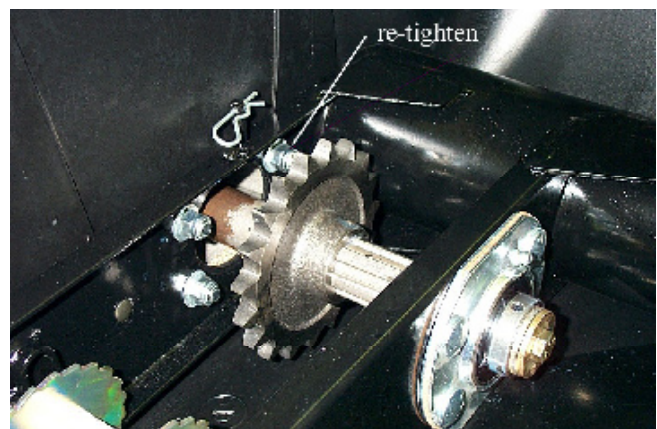

Figure 7-16. Re-tightening bolts.

SECTION 7 MAINTENANCE INFORMATION

7.3 HYDRAULIC BRAKES

7.3.1 GENERAL

Although the hydraulic brake system is self adjusting, the following require periodic attention:

7.3.2 BRAKE FLUID LEVEL

After every 50 hours of operation, check the brake fluid level by removing the master cylinder covers.

IMPORTANT

Thoroughly clean the master cylinder cover and surrounding area before removal.

The master cylinders are mounted tilted slightly back. When adding fluid, fill until the shallowest end of the fluid level in the well is approximately 1/2" from the top lip of the master cylinder (Figure 7-17).

If the brake fluid is below this level:

1. Add only fresh clean SILICONE - DOT 5 BRAKE FLUID (ARGO Part No. 126-19) to the correct level.
2. Replace the cover on each master cylinder, making sure the rubber gaskets are properly seated before tightening the cover screws. Tighten snug by hand only.

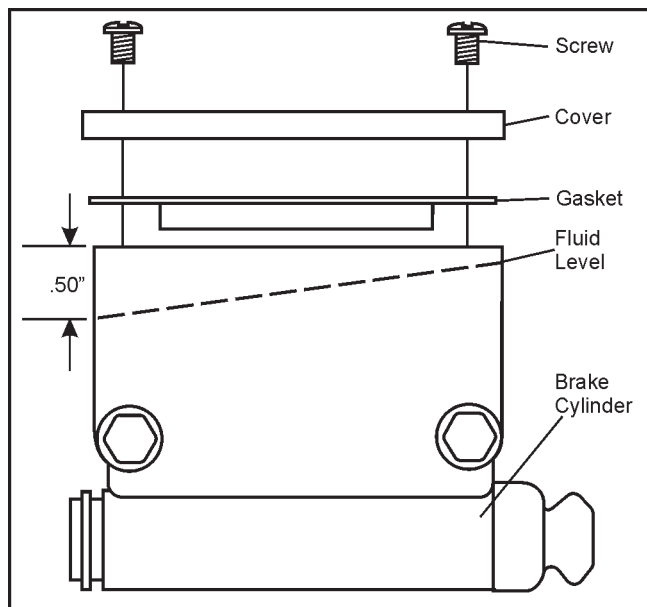

Figure 7-17. Hydraulic brake cylinder and fluid level

CAUTION

Do not overfill the brake master cylinders. Overfilling can cause seal damage.

Use only SILICONE - DOT5 BRAKE FLUID. Other brake fluid may not be compatible with ARGO brake components and operating temperatures. Use of other fluids will void the warranty.

7.3.3 CHANGING BRAKE FLUID

The inherent stability of Silicone DOT 5 Brake Fluid reduces the need for frequent brake fluid replacement. Inspect the fluid for degradation (discolouration or particles) during normal fluid level inspections. If discolouration has occurred, the brake fluid system should be drained, flushed and refilled with fresh brake fluid. If particles are evident in the fluid, drain the system, overhaul the master cylinder and the brake caliper before flushing and refilling. An ARGO dealer will perform these operations for you.

7.3.4 HYDRAULIC BRAKE PAD INSPECTION

Inspect the brake pads after every 25 hours of operation. Worn, glazed or contaminated brake pads affect the efficiency of the brake system. To inspect the pads, first remove the firewall.

To remove the firewall:

1. Turn the firewall release catch (located at the top of the firewall) counter-clockwise 1/4 turn.
2. Pull the top of the firewall rearward moving the throttle cable clear of the area at the steering column that it is routed through. Push the rubber gear shift boot back into the engine compartment.
3. Lift the firewall clear of the driving compartment.

Brake Pad Inspection Procedure

With the firewall removed, both hydraulic brake calipers are visible. Each caliper has 2 brake pads which are secured by cotter pins (Figure 7-19). Inspect all 4 brake pads.

Replace the pads when:

- the brake lining material molded to each metal backing plate is worn to 0.10" thickness. (Figure 7-18).
- the pads are glazed and brake performance is affected.
- the pads are contaminated with lubricant, and brake performance is affected.

SECTION 7

MAINTENANCE INFORMATION

To replace the brake pads:

Brake pads are easily replaced by removing the 2 cotter pins securing them within the brake caliper assembly and pulling each pad up and out of the caliper. See Figure 7-19. Pistons have to be pushed back in first, to allow clearance for the new pads. Slip the new pads into the caliper and install 2 new cotter pins bending the ends over to secure the pads in position. Pump the steering handle bar a few times to the left and to the right to build up proper pressure and to locate the pads in the caliper assembly.

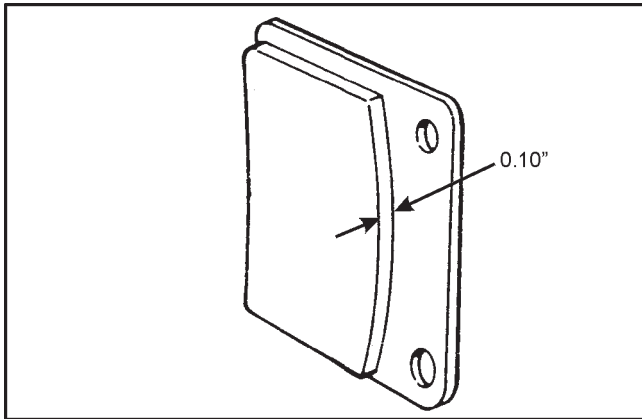

Figure 7-18. Brake pad wear, hydraulic brakes.

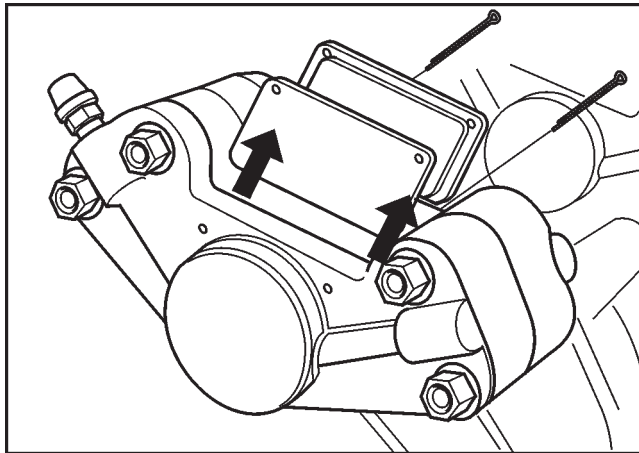

Figure 7-19. Removing the brake pads from the brake caliper.

To replace the firewall:

1. Position the firewall in the driving compartment.
2. Slide in the bottom of the firewall first and route the throttle cable through the open area at the steering column.
3. Push in the top of firewall up against the tabs located on the left and right hand side of the dash support.

4. Line up the firewall release catch with the mounting clasp on the frame and turn clockwise 1/4 turn to lock.
5. Reinstall the shifting lever boot.

⚠ WARNING

Do NOT operate the ARGO with the firewall removed.

7.3.5 HAND BRAKE ADJUSTMENT

The brake system has been factory adjusted to ensure proper braking effectiveness. However, **before the vehicle is used for the first time**, and after every 25 hours of operation, the adjustment of the brake **must** be inspected.

⚠ WARNING

The use of an improperly adjusted brake is a serious hazard, and could lead to vehicle damage or personal injury.

The lockable holding portion of the brake system is not a parking brake, and therefore is not designed to hold the vehicle in place for long periods of time. The holding brake is for short term use only.

When parking on an incline, engage the holding brake lever pin, leave the vehicle in gear, turn the engine off and block the vehicle's wheels.

The hand brake lever should be adjusted such that when squeezed and locked into position, it is capable of holding the vehicle from rolling on a grade. It should also ensure a good braking response when applied to stop the vehicle during normal operation. Loosen the locking jam nut at the adjustment end of the brake cable and thread the adjustment "OUT" to decrease brake lever travel and provide more braking action or "IN" to increase brake lever travel and less braking action. Retighten the jam nut.

⚠ CAUTION

If the holding brake system is too tight, excessive pressure in the brake system will damage the seals.

7.3.6 EMERGENCY/PARKING BRAKE ADJUSTMENT (ALL MODELS)

850-98 Emergency/Parking Brake Kit is available for servicing of the emergency/parking brake pads. The kit includes all necessary components and detailed servicing instructions.

SECTION 7 MAINTENANCE INFORMATION

NOTE

Both left and righthand side emergency/parking brake caliper pads should be changed in pairs. Do not attempt to just replace one side.

The emergency/parking brake system has been factory adjusted to ensure proper braking effectiveness. However, **before the vehicle is used for the first time**, and after every 25 hours of operation, the adjustment of the brake **must** be inspected.

⚠ WARNING

The use of an improperly adjusted emergency/parking brake is a serious hazard, and could lead to vehicle damage or personal injury.

The hand brake lever should be adjusted such that when pulled up firmly it is capable of holding the vehicle from rolling on a grade. It should also ensure a good braking response when applied to stop the vehicle during normal operation.

⚠ CAUTION

If the emergency/parking brake system is adjusted too tight when the lever is in the down position, overheating of the brake system will occur due to drag between brake pads and brake discs.

Adjusting the Emergency/Parking Brake

1. Remove the firewall.
2. Ensure the parking brake lever is fully down.
3. Locate the 850-72 Parking Brake Adjustment Bracket attached to the top of the transmission. Figure 7-20. Adjust to remove any slack in the cable that may be present between the brake lever, and the brake cams at the emergency/parking brake calipers. This may require physically pulling down on the equalizer flat bar to ensure all slack is eliminated. See Figure 7-21.

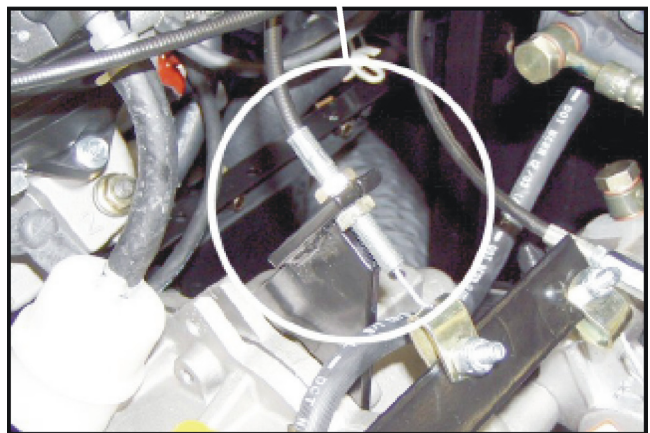

Figure 7-20. Location of Bracket

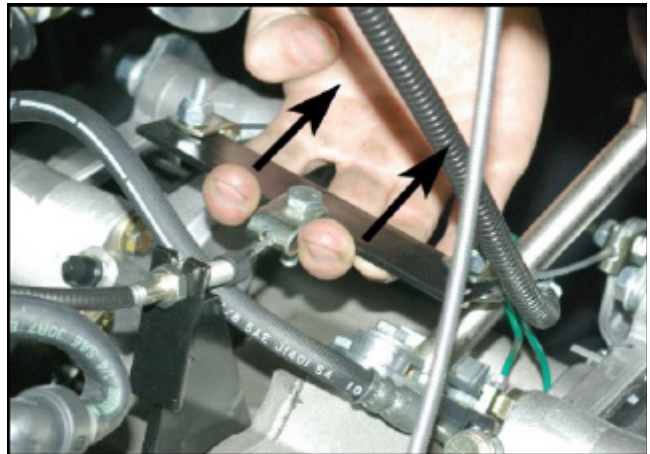

Figure 7-21. Equalizer Flat Bar.

4. Adjust the cable at the transmission until the cam levers are actually starting to pre-load the return springs and the cam lever actuation pin on the caliper, is centered in the "v-groove" of the cam. Figure 7-22.

SECTION 7 MAINTENANCE INFORMATION

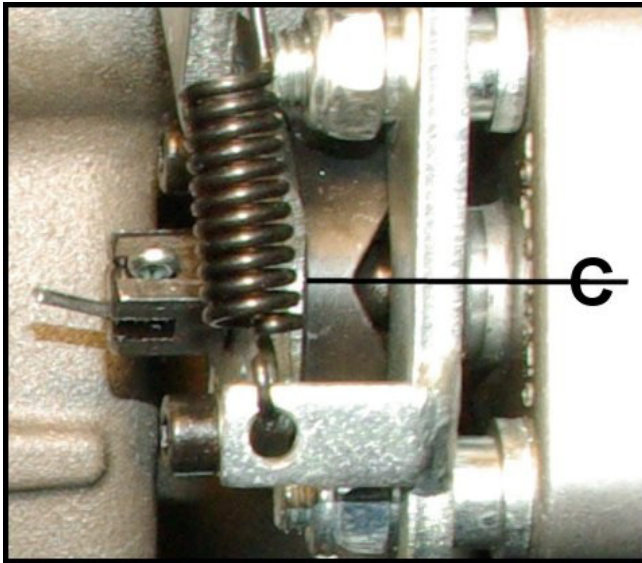

Figure 7-22. Pin Centered in "V-Groove".

5. Locate the castle nut at the mechanical brake cam lever and remove the cotter pin. *Figure 7-23.*

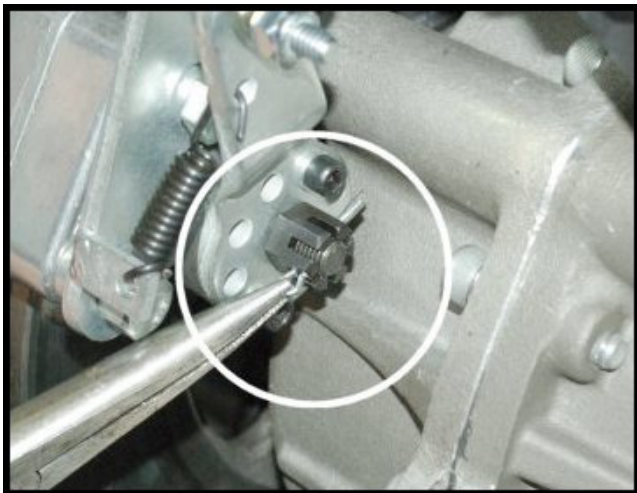

Figure 7-23. Castle Nut.

6. Loosen the castle nut until it can be threaded by hand.
7. Using a 0.004" feeler gauge or a piece of regular photo copy paper (such as used for these instructions), slip it between the emergency/parking brake pad and brake disc. Ensure that you push the opposite side pad up against the brake disc before setting this gap.
8. Slowly hand tighten the castle nut until the feeler gauge (or piece of paper), becomes snug between the pad and brake disc.
9. Back off the castle just enough for a *new* cotter pin to be

installed. The feeler gauge (or piece of paper), should pull out at this point with just the slightest bit of resistance.

10. Lock down jam nuts at the parking brake adjustment bracket on the transmission.
11. Check to ensure that the brakes are **NOT** engaged when the Brake Lever is in the down & off position.
12. Check for drag by driving without activating any brakes for about 100 feet. Stop and check for heat on the brake discs. They should both be cool (or no hotter than the beginning of the test). Adjust if necessary.
13. Check the effectiveness of the parking brake by parking the Argo on the steepest hill encountered and by loading to it's maximum working load. The parking brake should hold the Argo from moving.
14. Check the effectiveness of the emergency brake by activating it while coasting down a slight grade. The Argo should come to a controlled stop without pulling left or right. Re-adjust the brakes if necessary.
15. The emergency/parking brake should be checked for proper adjustment every 25 hours. **Note: Oil on the brake disc caused by improper chain oiling will temporarily reduce the effectiveness of the brakes.**

7.3.7 BRAKE PLUNGER ADJUSTMENT

IMPORTANT

It is critical that the master cylinder pistons are adjusted properly when the steering handlebars are in the centred position. Overheating of the brake system could occur due to the piston being adjusted too far in. This could cause a drag on the system and a possible brake lockup. On the other hand, the piston being adjusted too far out increases the distance the piston is required to travel to provide brake pressure. This can result in the steering arm contacting and/or bending the plunger pin guide tab resulting in compromised system operation.

1. Remove the firewall.
2. Pull back the rubber boot at both master cylinder plunger pins and check each piston location relative to the face of the master cylinder casting as illustrated in Figure 7-24. Use a straight edge against the face of the casting to ensure the piston is between zero and 0.5 mm depth in the master cylinder.
3. If adjustment is needed, loosen the jam nut and thread the

SECTION 7

MAINTENANCE INFORMATION

adjustable plunger pin either in or out as necessary.

- Loosen the set screw on each of the plunger pin collars and push them up against the plunger pin guide tabs. Apply Loctite # 242 to the set screw threads and re-secure the set screws.

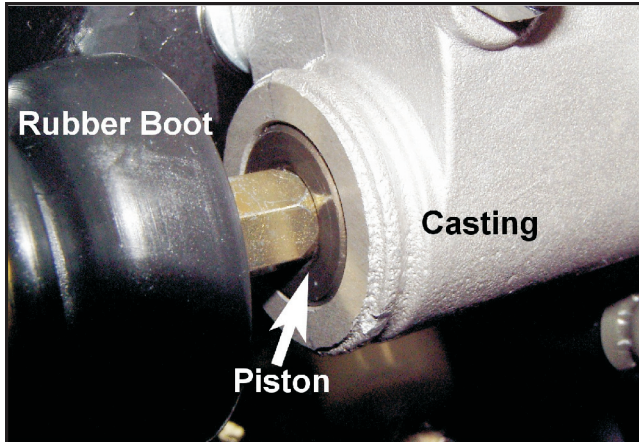

Figure 7-24. Location of piston.

7.3.8 BRAKE COOLING SYSTEM

Some vehicles with hydraulic brakes have a 12 volt fan forcing cool air from outside the engine compartment onto the brake components to protect the system from overheating. Overheating can damage the hydraulic brake components. Make sure the brake cooling fan is operating when the vehicle is being driven. The fan operates when the ignition switch is in the “run” position. Keep the brake cooling system in good working order by:

- cleaning debris from the air intake screen and ducts.
- keeping electrical connections tight and components securely mounted.

7.3.9 ENGINE COOLING & EXHAUST SYSTEM

Engine cooling air is drawn in on the right side of the engine compartment and expelled with the exhaust on the left side. Keep all ducting and screening in place.

Coolant Recommendations - Kohler Aegis

Use equal parts of ethylene glycol (anti-freeze) and water only. Distilled or deionized water is recommended, especially in areas where the water contains a high mineral content. Propylene glycol based anti-freeze is *not* recommended.

This mixture will provide protection from -37° C (-34° F) to 108° C (226° F). For protection and use outside the indicated temperature limits, follow the anti-freeze manufacturers instructions on the container, but do not exceed 70% anti-

freeze.

DO NOT use anti-freeze with stop-leak additive(s), or put any other additives in the cooling system.

Type: Permanent type of anti-freeze; green coloured

Mixed Ratio: 50% mixed

Freezing Point: -35° C (-31° F)

Coolant Capacity

LH690/775 2 L (2.18 U.S. qt)

⚠ WARNING

If the vehicle is equipped with an enclosed cab of any sort, make sure there is plenty of ventilation to avoid exposure to exhaust and engine fumes. Engine exhaust contains carbon monoxide; an odourless, colourless toxic gas that will cause serious personal injury or death. Inspect the exhaust system periodically for worn or damaged components. Listen for a change in exhaust or engine noise that may indicate a dangerous exhaust leak. If a leak is detected, have the exhaust system repaired immediately before further use.

Check the area around the exhaust system periodically for accumulated debris, particularly when travelling through dry vegetation. Failure to inspect and clean the exhaust system on a regular basis may create a fire hazard.

The tail pipe exiting through the left side of the upper body becomes very hot when the vehicle is operated. DO NOT ALLOW ANYONE TO TOUCH THE EXHAUST COMPONENTS. A SEVERE BURN CAN RESULT.

NOTE

An annual complete check over of your ARGO vehicle is recommended. This will reduce maintenance costs over the life of your vehicle and ensure it will function properly during use periods.

SECTION 7 MAINTENANCE INFORMATION

	BEFORE EACH USE	AFTER INITIAL			EVERY					SECTION REF.
		2hrs.	8hrs.	20hrs.	10hrs.	25hrs.	50hrs.	100hrs.	250hrs.	
CHECK COOLANT LEVEL (Avenger)	X									
CHECK FAN BELT TENSION (Avenger)	X									
CHECK FUEL LEVEL	X									2.2
CHECK TIRE INFLATION	X									7.2.6
CHECK TWIST GRIP THROTTLE OPERATION	X									2.2
CHECK HANDLEBAR TRAVEL	X									2.2
CHECK ENGINE INTAKE/EXH. FOR OBSTR.	X									2.2
CHECK THAT DRAIN PLUGS ARE IN PLACE	X									5.6
CHECK ENGINE OIL LEVEL	X									6.1.1
CHANGE ENGINE OIL & OIL FILTER										
- KOHLER				X			X			6.1.3
- BRIGGS & STRATTON			X				X			6.1.3
CHECK TRANSMISSION OIL LEVEL		X					X			6.2.1
CHANGE TRANSMISSION OIL				X				X		6.2.2
CLEAN AIR PRE-CLEANER (Briggs only)						X				6.3.1
CHECK CLEAN/REPLACE AIR FILTER								X		6.3.1
REPLACE FUEL FILTER									X	6.4.2
SERVICE DRIVER & DRIVEN CLUTCH									X	6.4.2
LUBRICATE DRIVE CHAINS					X					6.4.3
REMOVE, CLEAN & LUBE DRIVE CHAINS								X		6.4.3
LUBRICATE IDLER CHAINS					X					6.4.4
REMOVE, CLEAN & LUBE IDLER CHAINS								X		6.4.4
LUBRICATE AXLE FLANGE - OUTER CAVITY						X				6.4.5
LUBRICATE AXLE FLANGE - INNER CAVITY						X				6.4.5
LUBRICATE INNER AXLE BEARINGS								X		6.4.7
LUBRICATE IDLER BEARINGS								X		6.4.6
CHECK BATTERY FLUID LEVEL & CAPS							X			7.1.2
CLEAN BATTERY TERMINALS & CONNEX.								X		7.1.2
CLEAN BATTERY									X	7.1.2
CLEAN, ADJUST/REPLACE SPARK PLUGS								X		7.1.4
CHECK THE DRIVE BELT						X				7.2.1
CHECK NYLON SLIDERS - DRIVEN CLUTCH							X			7.2.2
CHECK SLIDERS - CHAIN TAKE-UP SYSTEM					X		X			7.2.4
CHECK & ADJUST IDLER CHAINS		X					X			7.2.5
INSPECT BRAKE PADS						X				7.3.4
INSPECT/ADJUST HAND HOLDING BRAKE						X				7.3.5
CHECK HYD. BRAKE FLUID LEVEL/COND.							X			7.3.2
CHECK FUEL TANK CONNECTIONS/LINES								X		
INSPECT WIRING HARNESS								X		
TIGHTEN BEARING EXT. BOLTS			X					X		7.2.8
CLEAN OUT SPARK ARRESTER							X			7.1.5

The intervals shown on the schedule are based on average operating conditions. Vehicles which are subjected to severe use and wet or dusty conditions will require more frequent servicing. Use only Argo replacement parts to ensure safe operation of the vehicle and to comply with the warranty coverage.

We strongly recommend that an Argo Dealer perform a complete check-over of your vehicle after the initial 20 hours of operation, then once each year. This will reduce maintenance costs over the life of your vehicle.

SECTION 8 TROUBLE SHOOTING

MALFUNCTION (SYMPTOM)	PROBABLE CAUSE	CORRECTIVE ACTION
Electric starter inoperative	<ol style="list-style-type: none"> 1. Loose electrical connections 2. Battery charge low or dead 3. Faulty starter motor 	<ol style="list-style-type: none"> 1. Clean and re-tighten electrical connections 2. Recharge battery or replace as necessary 3. Return the vehicle to an Argo dealer for servicing
Engine turns over but will not start	<ol style="list-style-type: none"> 1. Engine is cold and choke is not pulled out 2. Fuel tank is empty 3. Blocked fuel or air filter 4. Carburetor adjustment too lean 5. Spark plugs defective or fouled 6. Ignition system inoperative 7. Insufficient compression 	<ol style="list-style-type: none"> 1. Pull out the choke and try to start again 2. Refill tank 3. Remove obstruction or replace filter as necessary 4. Adjust as detailed in the engine manufacturer's manual 5. Clean and re-gap or replace 6. Have unit serviced by a properly trained and equipped mechanic 7. Take the vehicle to a factory authorized engine repair outlet
Engine will not run		<ol style="list-style-type: none"> 1. Refer to engine manual
Vehicle will not move or turn	<ol style="list-style-type: none"> 1. Transmission in neutral or not properly engaged in gear 2. Drive belt worn (see Section 7.2.1) 3. Clutch not engaging 4. Transmission failure 5. Brakes not functioning 6. Idler chain broken 7. Idler sprocket weld broken 	<ol style="list-style-type: none"> 1. Place gear shift properly in gear 2. Replace belt if worn excessively 3. Return the vehicle to an Argo dealer for servicing 4. Same as 3. above 5. Adjust caliper or replace brake pads 6. Repair or replace 7. Have vehicle serviced by an Argo dealer
Vehicle pulls to right	<ol style="list-style-type: none"> 1. Right tire pressure too low 2. Left tire pressure too high 3. Right brake engaged 4. Right side drive chain broken 	<ol style="list-style-type: none"> 1. Inflate all tires to the correct pressure 2. Same as above 3. Make sure the handlebar is held parallel to the dash. Adjust brake assembly if required. 4. Repair or replace
Vehicle pulls to left	<ol style="list-style-type: none"> 1. See "Vehicle pulls to right" - substitute right with left 	

SECTION 8 TROUBLE SHOOTING

MALFUNCTION (SYMPTOM)	PROBABLE CAUSE	CORRECTIVE ACTION
Severe vibration when vehicle is operated	<ol style="list-style-type: none"> 1. Engine loose on mounts 2. Driver or driven clutch or engine defective 3. Axle bent 4. Wheel rim bent 5. Worn or damaged drive belt 	<ol style="list-style-type: none"> 1. Take vehicle to an Argo dealer for service. 2. Same as above. 3. Remove and straighten or replace. 4. Replace. 5. Replace. Clutch service may be required.
Water leaks into lower body	<ol style="list-style-type: none"> 1. Leak has developed at the axle bearing flange 2. Bearing flange seal has been damaged 3. Water is leaking in around the outer bearing flange bolts 4. Lower body is cut or punctured 5. Drain plugs not in place 	<ol style="list-style-type: none"> 1. Replace the bearing flange gaskets. 2. Replace the bearing flange seal. 3. Caulk under 103-81 bolt heads with silicone sealer. 4. Repair or replace vehicle lower body 5. Secure drain plugs.
Tire leaks air	<ol style="list-style-type: none"> 1. Tire is punctured 2. Tire is not properly seated on bead 3. Position of air leak is not obvious 4. Defective valve 	<ol style="list-style-type: none"> 1. Remove tire from rim and repair the hole with a radial tire patch or install a tube in the tire. 2. Deflate tire and carefully push tire bead off the rim. Clean the rim bead area to remove dirt and foreign matter. Re-inflate tire. 3. Submerge tire and rim in a water tank. Air may be escaping through the rim halves or the valve stem. Repair as required. 4. Replace defective valve.
Hydraulic brakes are spongy, or there is excessive handle bar travel	<ol style="list-style-type: none"> 1. Air in hydraulic system 2. Leak in system 3. Loose brakes 	<ol style="list-style-type: none"> 1. Have an Argo dealer bleed the brake 2. Have an Argo dealer check all fittings, hoses, calipers and seals for loose connections or leakage. Refill as needed. 3. Adjust or tighten.
Brakes ineffective	<ol style="list-style-type: none"> 1. Pads have overheated and glazed 2. Pads worn beyond 0.10" 3. Pads are contaminated with lubricant 	<ol style="list-style-type: none"> 1. Have the pads cleaned by an Argo dealer or replace pads. 2. Replace. 3. Have the pads cleaned by an Argo dealer or replace pads.
There is a loud bang when the vehicle is turned right or left	<ol style="list-style-type: none"> 1. Idler chains worn/loose 2. Drive chains worn/loose 	<ol style="list-style-type: none"> 1. Adjust/replace idler chains as required. 2. Adjust/replace drive chains as required.

SECTION 9 CLEANING AND STORAGE

9.1 CLEANING THE VEHICLE

Wash the vehicle body with a household detergent and rinse with water. Flush dirt out of the lower body by using a high pressure sprayer or garden hose after removing the drain plugs. After the bottom of the vehicle is dry, lubricate the drive chains with ARGO chain Lube. Make sure the drain plugs are replaced.

9.2 STORING THE VEHICLE

When the vehicle is stored for an extended period, the following preparation is required:

Clean the Vehicle

Remove all dirt and water from the vehicle body as directed above.

Remove the drain plugs if the vehicle is not fully sheltered from the elements.

CAUTION

Any water accumulation in the vehicle will, over time, destroy chains, sprockets and bearings. Grease all bearings and flanges (refer to Section 6.4.5).

NOTE

Bearing corrosion due to inadequate preparation for storage is the leading cause of premature bearing failure.

Drain the Fuel System

Insert a siphon hose into the gas tank through the filler neck and drain the gasoline. Start the engine and run it until all fuel in the system is consumed.

OR

Add fuel stabilizer (ARGO Part No. 127-77) to the fuel tank and fill with fresh gasoline. Run the engine for a few minutes to allow the treated fuel to reach the carburetor.

Prepare the Battery for Storage

Remove the battery from the vehicle. Clean it and charge it with a battery charger. Coat the battery terminals with a multi-purpose grease to prevent corrosion. Store the battery in a cool dry place.

WARNING

Do not store the battery near flames, sparks or any source of fire. Batteries can explode if exposed to flames or sparks, causing serious personal injury.

Recharge the battery monthly.

Protect the Electrical System

Spray the wiring harnesses and all the electrical connections with a silicone based lubricant (WD40 or equivalent) to prevent corrosion.

Carefully inspect the wiring for loose connections, bare wires or corrosion. Repair as necessary.

Raise the Vehicle

Place blocks under the front and rear of the vehicle to raise the tires off the ground. The blocks must be placed under the frame members to prevent body damage (Figure 9-1).

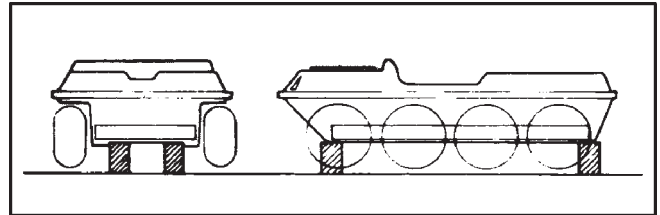











Figure 9-1 Correct placement of blocks











Preparing the Engine for Storage

Read the engine operator's manual and carry out all recommended storage procedures.











SECTION 10 POTENTIAL HAZARDS

	POTENTIAL HAZARD	WHAT CAN HAPPEN	HOW TO AVOID THE HAZARD
	Operating the Argo without reading and understanding the Operator's Manual	The risk of accident is greatly increased if the operator does not know how to operate the Argo properly in different situations and on different types of terrain.	New or inexperienced operators should read and understand the Operator's Manual. They should then regularly practice the operating techniques described in this Operator's Manual.
	Allowing anyone under age 16 to operate this vehicle.	Children under the age of 16 may not have the skills, abilities, or judgement needed to operate the Argo safely and may be involved in an accident causing severe injury or death.	No one under the age of 16 should be allowed to operate the Argo.
	Operating or riding as a passenger in the Argo without wearing an approved motorcycle helmet, eye protection, and protective clothing.	Operating or driving without an approved motorcycle helmet increases the chance of severe head injury or death in the event of an accident. Operating or driving without eye protection can result in an accident and increases your chances of a severe injury in the event of an accident.	Wear an approved safety helmet and eye protection when driving or riding in the vehicle.
	Operating the Argo after or while consuming alcohol or drugs.	Could seriously affect your judgement, cause you to react more slowly, and affect your balance and perception. This could result in an accident.	Never allow anyone under the influence of alcohol or any other intoxicating substance to drive or ride in the vehicle. Never use with drugs or alcohol.
	Carrying passengers in the dump box.	Riders can fall off and be killed.	No riders in the dump box.
	Carrying cargo when using the Argo in water.	Argo vehicles may sink if they fill with water, resulting in injury or drowning to driver and passengers. If the vehicle upsets or swamps, exposure in cold water significantly reduces the chance of survival.	Be especially cautious when operating a loaded vehicle (cargo and/or passengers) in water. Observe the capacity limits. Do not enter water if the vehicle is overloaded. Use extra caution when operating the Argo in cold water.
	Carrying cargo in the dump box when used in water.	Greatly reduces your ability to balance and control the Argo in the water. Could cause an accident, including capsizing and sinking, resulting in injury or drowning to driver and passengers.	Do not use the dump box equipped Argo in water.
	Operating the Argo in water without drain plugs properly installed.	Will cause the vehicle to fill with water and cause it to capsize or sink, which could result in injury or drowning to driver and passengers.	Always make sure the drain plugs are properly installed in the Argo as described in the Operator's Manual.
	Using the Argo to tow anything in the water other than an Argo amphibious trailer.	Greatly reduces your ability to balance and control the Argo in the water. Could cause an accident, including capsizing and sinking, which could result in injury or drowning to driver and passengers.	Never tow anything other than an Argo amphibious trailer when the Argo is used in water. Keep cargo low and centered in the trailer, especially if used in water.
	Operating the Argo in rough water.	Greatly reduces your ability to balance and control the Argo in the water. Could cause an accident, including capsizing and sinking, which could result in injury or drowning to driver and passengers.	Do not attempt to navigate any body of water with a strong current. Avoid water operation under windy conditions. Do not attempt to cross large bodies of water. Stay close to shore in case of emergency and you have to leave the water.











SECTION 10 POTENTIAL HAZARDS

	POTENTIAL HAZARD	WHAT CAN HAPPEN	HOW TO AVOID THE HAZARD
	Operating or driving the Argo in water without the occupants wearing an approved personal flotation device (PFD).	If you lose control of the Argo in water and it capsizes and sinks, the driver and passengers may be injured or drown.	All occupants must wear an approved personal flotation device (PFD) or life jacket while travelling in water.
	Operating the Argo in water without taking along a paddle.	If you run out of gas or have an engine failure the Argo will not be able to move under its own power and you may be stranded.	Equip the vehicle with a paddle and bailing can.
	Failure of driver and passengers to adjust positions so that the vehicle is floating level when operating the Argo in water.	Water may enter the vehicle and cause it to capsize or sink, which could result in injury or drowning to driver and passengers.	When using the Argo in water, adjust the position of cargo and passengers so the vehicle floats level.
	Failure to enter the water correctly.	You may cause waves, which will enter the Argo and cause it to capsize or sink, which could result in injury or drowning to driver and passengers.	The point of entry should be free of rocks, stumps and other obstacles. Enter the water from a firm, gradual slope whenever possible. Be careful not to submerge the bumper as you enter the water.
	Carrying more than specified number of people in an Argo, either on land or in water.	Greatly reduces ability to balance and control the Argo on both land and in the water and could cause an accident, resulting in injury or death to driver and passengers.	Never exceed the load capacity of the Argo: 6x6 - Land-4 people/317 kg (700 lbs.) - Water-2 people/227 kg (500 lbs.) 8x8 - Land-6 people/454 kg (1000 lbs.) - Water-4 people/408 kg (900 lbs.)
	Overloading the vehicle.	Heavy loads and high loads decrease the stability of the vehicle and may cause it to roll. Trying to steer an overloaded vehicle can overheat the brakes. This will lead to brake fade which means loss of steering control and the ability to stop the vehicle. Overloading your vehicle can lead to premature brake system failures and costly damage to drive chains, axles or bearings.	Follow the recommended load capacity for your vehicle listed in Section 1.
	Overloading cargo area in 6x6.	Exceeding the weight limitation will decrease the stability of the vehicle on inclines and increase the possibility of rolling over backwards when climbing a grade.	The rear compartment capacity of all 6 wheel Argo vehicles is 65 kg (140 lbs). Do not exceed this weight in the rear compartment.
	Failure to fasten seat belts if the Argo is equipped with rollover protection.	If the Argo overturns, the driver and passengers may be thrown from the vehicle and the roll bar or roll cage could strike them.	Seat belts must be properly adjusted and worn by all occupants at all times EXCEPT when operating in water.
	Failure to unfasten seat belts (if the Argo is so equipped) when the vehicle is in water.	If the Argo capsizes or sinks the driver and passengers may be unable to unfasten their seat belts and may drown.	Do not use seat belts or any passenger restraining device while operating an Argo in water.
	Failure to inspect the Argo before operating. Failure to properly maintain the Argo.	Increases the possibility of an accident or equipment damage.	Always inspect your Argo each time you use it to make sure it is in safe operating condition. Always follow the inspection and maintenance procedures and schedules described in this Operator's Manual.

SECTION 10 POTENTIAL HAZARDS

	POTENTIAL HAZARD	WHAT CAN HAPPEN	HOW TO AVOID THE HAZARD
	Operating the Argo with improper tires or with improper or uneven tire pressure.	Use of improper tires on the Argo, or operation of the Argo with improper or uneven tire pressure may cause loss of control increasing your risk of an accident.	Always use the size and type tires specified in this Operator's Manual for this Argo. Always maintain proper tire pressure as described in this Operator's Manual.
	Operating the Argo with improper modifications.	Improper installation of accessories or modification of the Argo may cause changes in handling which in some situations could lead to an accident.	Never modify the Argo through improper installation or improper use of accessories. All parts and accessories added to this Argo should be genuine Argo components designed for use on the Argo and should be installed and used according to instructions. If you have questions, consult an authorized Argo dealer or contact Ontario Drive & Gear Limited at 1-519-662-4000
	Applying brakes suddenly when going downhill.	Sudden braking can cause the vehicle to roll over forward.	Gently apply the brakes to control downward vehicle speed. Do not jam on the brakes while travelling downhill.
	Operating the Argo on paved surfaces.	Pavement may seriously affect handling and control.	Do not drive your vehicle on asphalt or concrete roadways.
	Operating Argo on public streets, roads or highways.	A collision can occur with another vehicle.	Never drive on public roads.
	Operating at excessive speeds.	Personal injury or vehicle damage may result.	Do not drive the vehicle at high speeds over unfamiliar or rough terrain. Never operate at speeds too fast for your skills or the conditions.
	Failure to use extra care when operating the Argo on unfamiliar terrain.	Personal injury or vehicle damage may result.	Do not drive the vehicle at high speeds over unfamiliar or rough terrain.
	Failure to use extra care when operating on rough, slippery or loose terrain.	Could cause loss of traction or vehicle control, which could result in an accident, including an overturn.	Do not operate on rough, slippery or loose terrain until you have learned and practised the skills necessary to control the Argo on such terrain.
	Turning improperly.	When turning, the back of the vehicle swings to the opposite direction of the turn, creating a risk of hitting persons or objects. Sharp turns, especially at high speeds or when heavily loaded, may cause the vehicle to roll over.	Always take precautions when making turns to avoid rolling the vehicle or hitting persons or objects. Slow the vehicle down before making a turn. Do not apply the brakes too suddenly.
	Driving on inclines with a loaded vehicle.	Heavy loads and high loads decrease the stability of the vehicle and may cause it to roll.	Use extreme CAUTION when negotiating inclines with a loaded vehicle. Be prepared to shift occupant weight and load forward or have passengers get out of the vehicle to walk up an incline.
	Going downhill improperly.	Sudden braking can cause the vehicle to roll over forwards.	Avoid steep declines when possible. When a steep decline cannot be avoided, shift occupant weight to the rear of the vehicle to prevent the vehicle from rolling over.

SECTION 10 POTENTIAL HAZARDS

	POTENTIAL HAZARD	WHAT CAN HAPPEN	HOW TO AVOID THE HAZARD
	Improperly crossing hills or turning on hills.	Side slope operation greatly increases the risk of rolling the vehicle over sideways. Prolonged side slope operation may cause engine damage.	Do not drive your vehicle across the side of a hill. Observe the engine angle of operation limitations in Section 5.2.
	Stalling or rolling backwards while climbing a hill.	Could cause loss of control which could lead to an accident including an overturn.	Try to avoid steep hills. Maintain steady speed when climbing a hill. If you lose all forward speed: - keep weight uphill - lean toward the hill - slowly coast backwards down the hill using the handlebar brake
	Improperly operating over obstacles.	Personal injury or vehicle damage may result.	Before operating in a new area, check for obstacles. Never attempt to drive over large obstacles such as large rocks or fallen trees. When you go over obstacles always follow proper procedures as described in this Operator's Manual.
	Skidding or sliding.	You may lose control of the Argo. You may also regain traction unexpectedly which may cause the Argo to overturn.	Learn to safely control skidding or sliding by practising at slow speeds and on level, smooth terrain. On extremely slippery surfaces, such as ice, go slowly and be very cautious in order to reduce the chance of skidding or sliding out of control.
	Improperly operating in reverse.	You could hit an obstacle or person behind you resulting in serious injury.	Carefully practice backing up and turning in an open area until you become accustomed to this procedure. Take precautions to avoid hitting persons or objects.
	Use of the holding brake as a parking brake.	The holding brake system is not a parking brake, and therefore is not designed to hold the vehicle in place for long periods of time. The holding brake is for short term use only. The hydraulic brake pressure could drop over time, releasing the brakes, allowing the vehicle to roll into persons or objects, causing serious injury.	When parking on an incline, engage the holding brake, leave the vehicle in gear, turn the engine off and block the vehicle's wheels.
	Using the firewall to brace your knees.	Damage to the firewall and serious personal injury can result from the driven clutch wearing through the firewall.	Do not push against the firewall with your knees.
	Running the engine in a closed building or confined area.	Engine exhaust gases contain poisonous carbon monoxide. Carbon monoxide is odourless, colourless and can cause serious injury or death.	Never start or run the engine in a closed building or confined area.
	Adding fuel while the engine is running or hot.	Gasoline is extremely flammable and can explode under certain conditions, causing serious injury or death.	Do not add fuel while the engine is running or hot.
	Filling outboard motor fuel tanks while they are in the Argo.	Gasoline is extremely flammable and can explode if ignited, causing serious injury or death.	Fill outboard motor fuel tanks outside of the vehicle. Wipe up any spilled fuel immediately. Do not carry or store fuel tanks in a vehicle equipped with a cab or convertible top unless adequate ventilation is provided.

SECTION 11 ACCESSORY INFORMATION

11.1 GENERAL

This section deals with accessories that have been specifically designed for the ARGO and can be purchased separately from your dealer. Special operating procedures and safety precautions must be observed before operating or using certain accessories.

11.2 CARGO TIE DOWNS (Part No. 614-06)

Cargo tie downs are intended to assist in securing a load in the rear compartment of any Argo. Use rope or elastic cords, laced over the load and through the tie down rings, to hold the load in place.

CAUTION

Never attempt to raise the vehicle by using the tie down rings as lifting points.

WARNING

Never exceed gross vehicle weight. Never exceed the maximum rear compartment weight for 6-wheelers (65 kg/140 lbs.).

11.3 ARGO TRACK SYSTEMS (Standard Track - Part Nos. 615-43 & 815-42K, Super Track - Part Nos. 625-43 & 825-42K & Rubber Track - Part Nos. 625-50 & 825-50-1)

There are three different types of track systems available for use with the Argo, the standard track system, the super track system and the rubber track system. Standard tracks and super tracks are similar in basic design and use the same pins and lock collars to join the segments together. However, super tracks and rubber tracks are wider than standard tracks and require axle extensions and studs assembled to each wheel hub.

The 625-50 & 825-50-1 Rubber Track Systems are NOT a segmented track. This track is installed over the existing tires and is hinged in one location only.

The track systems spread the weight of the vehicle over a larger area than the tires, thereby reducing the ground pressure and allowing the vehicle to stay on top of, rather than sinking into, soft terrain.

The segmented track design allows the replacement of only those segments that may have become damaged or worn with use.

CAUTION

Only use track segments that show the Argo trademark. Other track systems may fail and damage axles, bearings and the final drive system.

Track segments will wear prematurely if used over pavement, gravel, rock or on any abrasive surface.

11.3.1 Assembly Instructions (Standard and Super Track)

1. Join 2 track segments together, lining up the 1/4" holes. See Fig. 11-1. Hammer a track pin through the holes, placing the lock bushing as shown in the centre space provided. When installing the track pins which hold the track segments together, alternate the direction in which the pins are pushed through the track segment holes. See Fig. 11-2.

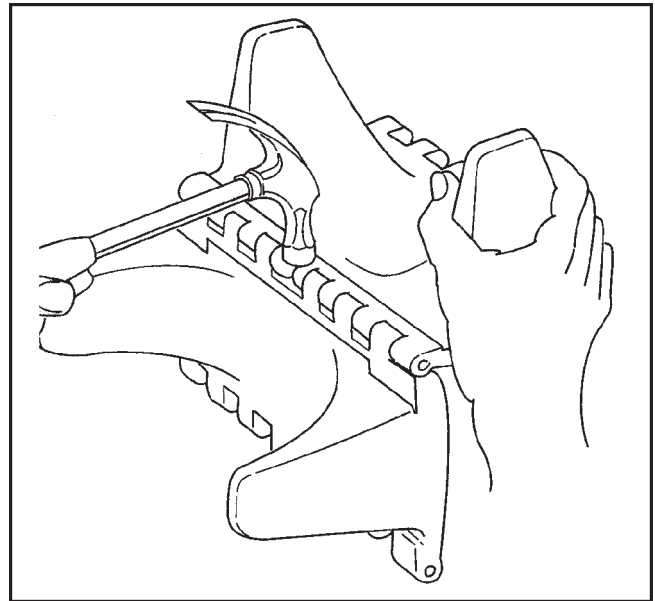

Figure 11-1. Track Assembly.

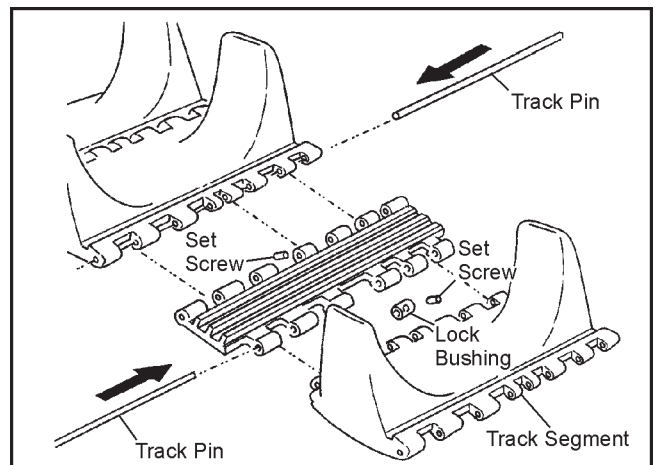

Figure 11-2. Track Assembly.

SECTION 11 ACCESSORY INFORMATION

NOTE

Centre the track pin so that it does not stick out on either side of the track.

2. Apply a drop of blue 242 Loctite to the hole in the lock bushing and the set screw. Install the set screw using a 1/8" Allen wrench. **TIGHTEN SECURELY. Set screw must seat in ground recess of track pin.**
3. Assemble two complete tracks:
 - 6 wheel models - 31 segments each side for 6x6 Frontier; 29 segments for V699 models and 28 segments for all previous models
 - 1 half segment
 - 8 wheel models - 39 segments each side for Avengers & 8x8 Frontier; 36 segments for all previous models
 - 1 half segment

IMPORTANT: The actual number of track segments used will vary and will be determined when the tracks are being installed. Wrap the track assembly around the tires. Ensure they are snug to the front and rear deflated tires. Then add or remove segments until there is a gap of approximately 0 to 1" between the adjoining segments for all Avenger and Frontier models or 2" to 2-1/2" for all other models. These will have to be drawn together using two C-clamp style vise grips to install the connecting pin.

CAUTION

Supertrack & Rubber track systems require the assembly of 605-77 axle extensions and 126-08 extension studs to each wheel hub before installation of the tracks. Failure to install these components will cause severe damage to the lower body.

Note: Axle extensions are recommended for use only with Argo Super tracks and Rubber tracks and should be removed for tire-only use.

11.3.2 Installing the Axle Extension (Supertrack & Rubber Track)

4. Raise the vehicle off the ground and remove the wheels using 3/4" socket.
5. Install the extension studs on all of the vehicle wheel studs and tighten securely with a 5/8" socket. See Fig. 11-3.
6. Place the axle extension collars onto the extension studs and seat firmly against the axle hub plate. The small hole must face away from the hub plate.

NOTE

The extension studs have hexagonal sides and must sit properly within the slots on the axle extension (See Fig. 11-4). If the extension studs are misaligned with the slots of the axle extension collar when tightened, adjust each stud as necessary by tightening them further (never by loosening them), until alignment allows for the extension collar to slide on easily (by hand), up against the axle hub. Torque to a minimum of 40 ft lbs. Once the extension studs are tightened and aligned correctly, they will not require re-tightening unless they are removed. However, it is very important that with the Super Tracks and Rubber Tracks installed, the wheel nuts of the Argo are tightened to 55 ft. lbs. (75 N.m) initially, re-torqued after the first 10 hours of operation, then again after the next 10 hours, followed by re-torquing every 25 hours of operation.

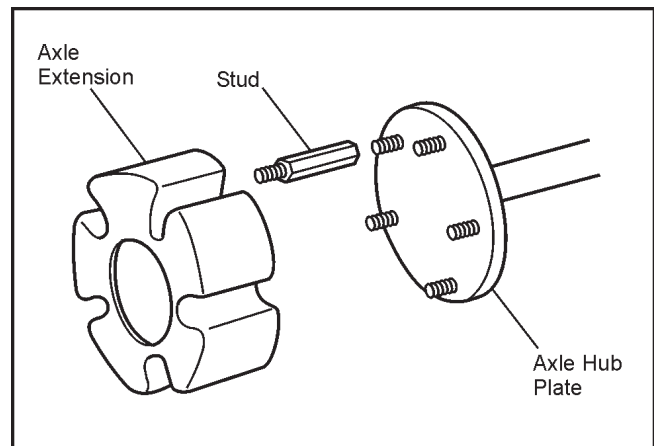

Figure 11-3. Installing the Axle Extensions.

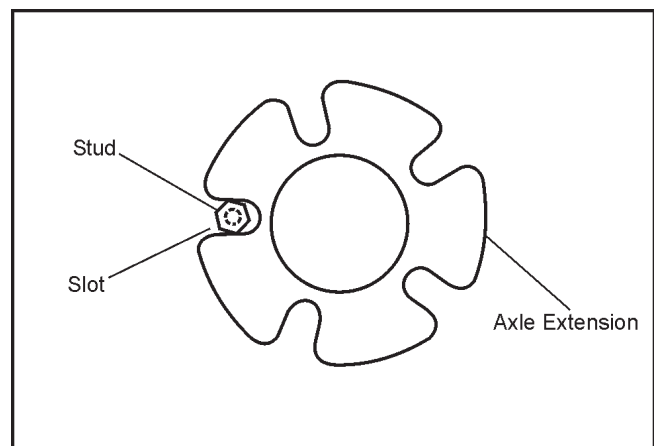

Figure 11-4. Check Stud Position in Axle Extension.

CAUTION

Damage to the extension studs, bolts, or axle extension may occur if the extension studs are not tightened correctly. Use good judgement when installing.

SECTION 11 ACCESSORY INFORMATION

7. For all Avenger and Frontier models, tires must be checked for size and installed in a specific order as shown in the charts, Figure 11-7. If this is not done, chain windup will happen causing damage to the chain tensioning system and possibly, to other drive system components. Tires should be sized this way:
- With the tires still off the machine, inflate them all to 5.0 psi.
 - Measure the circumference of each tire using a suitable tape measure, being sure to measure around the center-line of the tire. Figure 11-5. Write down the measurement on each tire. Figure 11-6.
 - Install the tires as shown in the chart (Figure 11-7).



Figure 11-5. Measuring the tire.

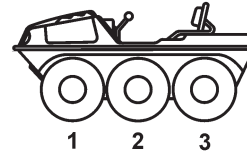

Figure 11-6. Marking the tire.

NOTE

Two tires that measure a certain difference in circumference when at 5 psi, should always be the same difference in circumference when at equal pressure. **Check tire pressure every 10 hours and adjust to the pressures shown in the chart.**

Wheel Position - 6x6



	Wheel #1	Wheel #2	Wheel #3
Measured Size	Smallest	Mid-size	Largest
Tire Pressure	5 psi	5 psi	6 psi

Wheel Position - 8x8

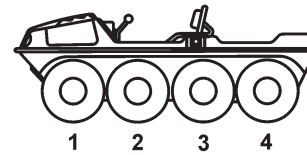

	Wheel #1	Wheel #2	Wheel #3	Wheel #4
Measured Size	Smallest	Largest	Second Largest	Second Smallest
Tire Pressure	5 psi	7 psi	7 psi	6 psi
Tire Direction *	Standard	Reversed	Reversed	Standard

*Note: Standard = Standard Argo tire installation
 Reversed = Opposite to the normal Argo tire installation
 Tire tread direction is not as important as tire size position or tire pressure. It has some benefit in lowered chain loads but should be considered only if tire size position requirements are met.

Figure 11-7. Tire Sizing Chart.

IMPORTANT

BEFORE INSTALLING THE RUBBER TRACK SYSTEM, IT IS CRITICAL THAT TIRE SIZING IS PERFORMED AND THE TIRES INSTALLED AS SHOWN IN THE CHART (Figure 11-7). PLEASE REVIEW AND ENSURE YOU HAVE FOLLOWED THE PREVIOUS INSTRUCTION BEFORE PROCEEDING WITH THE FOLLOWING:

- Using a 3/4" socket, install the wheels. Use extreme care and allow extra installation time to protect the axle extensions from damage. Torque the wheel nuts to 55 ft. lbs. (75 N.m).

11.3.3 Standard and Super Track Installation

NOTE

If the tracks, when laid on the ground, appear to curve to one side, then turn one set so that they curve in opposite directions, as shown in Fig. 11-8. If this is **NOT** done, the vehicle may pull to the left or right during straight line operation.

SECTION 11 ACCESSORY INFORMATION

9. Lay the two assembled tracks on the ground. Drive the vehicle forward onto the tracks until only two segments are in front of the tires.
10. Pull the remaining track around the rear tire and forward to the front of the vehicle.
11. Deflate the front and rear tires for easier installation of the final track pin. The gap between the adjoining segments should be between 0 to 1" for Avenger and Frontier models and 2 to 2-1/2" for all other models. Adjust the quantity of track segments to meet this requirement.

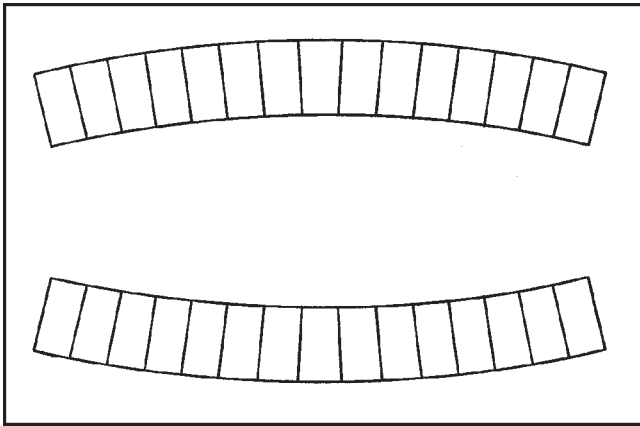

Figure 11-8. Track Assembly.

12. Join the two ends of the track and secure them in place with C-clamps as shown in Fig. 11-9, so that the 1/4" holes are lined up.
13. Install the final track pin as in instruction No.1 & 2. Remove the C-clamps.
14. Re-inflate the tires as shown in the charts in Figure 11-7.
Note: Putting too much tension in the track will severely stress the axles, bearings and frame.
15. Allow the tires to reach temperature of operating conditions. Recheck the tire inflation at operating conditions before operation.

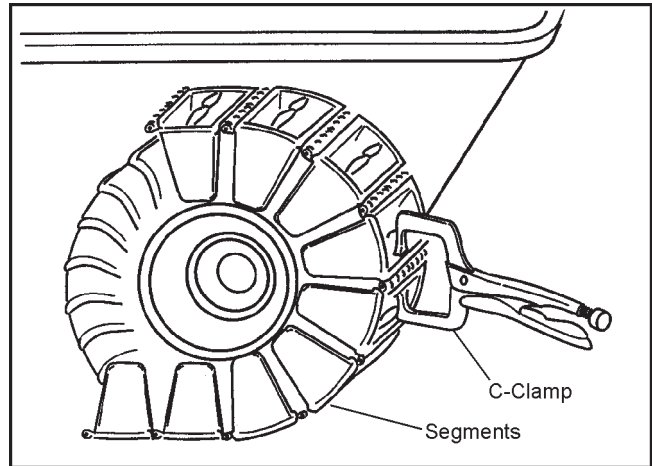

Figure 11-9. Track Assembly.

Temperature changes will cause the segments to expand or contract and will also change the tire pressure. In order to maintain suitable tension on the track system, observe the following precautions:

CAUTION

DO NOT over inflate tires. Lower body damage could result from track segments rubbing against the polyethylene body material. Pay special attention to the tracks during the first few "run-in" hours of use.

If the tracks become slack, start hitting the lower body, or the tires begin to slip inside the tracks, DO NOT INCREASE TIRE PRESSURE ABOVE WHAT IS SHOWN IN THE CHART (Figure 11-7). REMOVE THE HALF SEGMENT FROM EACH TRACK, OR REMOVE A FULL SEGMENT AND ADD THE HALF SEGMENT.

Over inflation of the tires will cause excessive and premature wear of the tires and ARGO track system, and may cause axle and/or axle bearing damage. Under inflation of the tires may allow them to slip in the track or may cause the tire to pop off the wheel rim. Under certain conditions, the tires may climb out of the track system during a turn or side hill operation. Check that all tires are correctly inflated, and avoid sharp high speed turns when the Argo is heavily loaded.

11.3.4 Removal of Standard and Super Tracks

1. Use C-clamp to take tension off of track pin, as in Fig.11-9.
2. Loosen the set screw in the lock bushing of the track pin. Store set screw in a safe place.
3. Using a 1/4" pin punch and hammer, start the removal

SECTION 11

ACCESSORY INFORMATION

of the track pin from the vehicle side of the track. Once started, pull the pin out of the segment with Vise Grip.

4. Pull the track off the top of the tires and drive the vehicle out of the tracks.

11.3.5 Operating Precautions (All Track Systems)

An Argo equipped with tracks has a reduced carrying capacity in water (See Section 1.4.1). Refer to Section 5.6 of this manual for additional information on safe operation in water.

Do not use the Argo in water when equipped with tracks unless it is also equipped with an outboard motor. The tracks do not propel the Argo in water.

CAUTION

CAUTION should be observed when operating in winter conditions and a drop in temperature occurs. Snow and slush accumulation in the track could freeze, resulting in damage to the track system. Slush, snow and ice accumulation should be cleared from the axles and track periodically to prevent build-up.

CAUTION should be observed when using any track system on an Argo. Make sure the steel connecting pins are properly secured in each track segment. Failure to secure the track pins in the segment can result in lower body damage if the track pin moves out of the segment toward the lower body.

WARNING

EXTREME CAUTION must be observed when using the track systems on icy surfaces. Steering and braking effectiveness will be reduced. Reduce speed.

EXTREME CAUTION must be observed when crossing ice-covered water. The vehicle may sink if it breaks through the ice surface and fills with water. Make sure drain plugs are securely in place and do not overload the vehicle. Should the vehicle break through the ice, attempt to back the vehicle out, taking care that water does not enter the engine compartment. Refer to section 5.7.1 of this manual for additional information on safe operation on ice-covered water.

11.3.6 Standard Tracks

Standard Tracks are intended to extend the use of the Argo so that it can be driven over softer terrain conditions such as mud, swamp, muskeg and snow. The standard track system is well suited for a wide variety of terrain conditions. However, for deep snow conditions, the Super Track system will outperform the standard track system.

11.3.7 Super Tracks

Super Tracks provide the maximum “flotation” available for the Argo. They are very effective in deep snow, swamp and muskeg.

Care must be used while traveling over uneven ground conditions. The extra width of the segments can lead to the segments tipping to one side on the tire to such an extent that the tire guide forces the tire bead off the rim. SUPER TRACKS ARE NOT RECOMMENDED FOR TRAVEL OVER LOGS, STUMPS OR ROCKS.

11.3.8 625-50 & 825-50-1 Rubber Tracks

Rubber tracks provide the same flotation as Super Tracks. They are a highly durable belt track design constructed of rubber. This system has low rolling resistance.

11.3.9 Installation Instructions (625-50 & 825-50-1 Rubber Track Systems)

1. Install the Hinge Assembly as described in the 625-50 or 825-50-1 Rubber Track Kit instructions.
2. Install axle extension and extension studs to the wheel hubs following the guidelines as described in 11.3.2 of this section.
3. Tires must be checked for size and installed in a specific order as shown in section 11.3.2. step 7.
4. Remove the air from the front and rear tires.

Installing The Tracks To The Vehicle

IMPORTANT

BEFORE INSTALLING THE RUBBER TRACK SYSTEM, IT IS CRITICAL THAT TIRE SIZING IS PERFORMED AND THE TIRES INSTALLED AS SHOWN IN THE CHART (Figure 11-7). PLEASE REVIEW AND ENSURE YOU HAVE FOLLOWED THE PREVIOUS INSTRUCTION BEFORE PROCEEDING WITH THE FOLLOWING:

5. Lay the two assembled tracks on the floor.
6. Drive the vehicle forward onto the tracks leaving approximately 8" extending past the front tires.
7. Pull the remaining track around the rear tire and forward to the front of the vehicle.

SECTION 11 ACCESSORY INFORMATION

8. Deflate the front and rear (or all tires) for easier installation of the final track pin.
9. Join the two ends of the track and secure them in place with C-Clamps as shown in Figure 11-10, so that the holes of the hinge lacing line up.

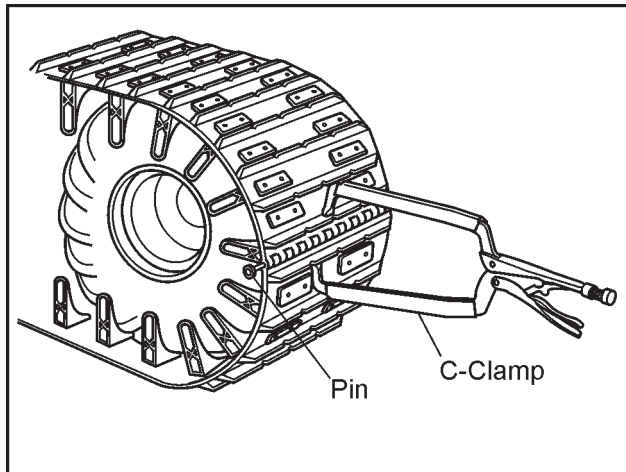

Figure 11-10. Securing with C-clamps.

10. Insert the 825-56 Track Pin through one of the 108-23 washers and then through the hinge lacing. **Be sure to install the pin from the outside edge of the track so the end with the cotter pin hole ends up nearest the vehicle lower body.**
11. Secure the Track Pin in the hinge with a 108-23 washer and 100-100 cotter pin at end closest to the vehicle body.
12. Re-inflate the tires as shown in the chart. With the tires installed and inflated as shown in the chart, there should be 2 to 3 inches between the bottom of the second (or third) tire and the inside surface of the track when the vehicle is elevated. Figure 11-11 & 11-12 for Avenger and Figure 11-13 & 11-14 for Frontier. This may require the installation of a track extension or additional hinge kit. For Avengers with typical 79-80" tires, the total track length should be 235" (including hinges and track extensions.) For Frontiers with typical 76-77" tires, the total track length should be 189" pin to pin. The extension can be easily removed if the wheels slip within the track during winter use. **NOTE: Putting too much tension in the track will severely stress the axles, bearings and frame.**



Figure 11-11. Measuring the gap of the mid tires - Avenger.



Figure 11-12. Measuring the gap of the mid tires - Avenger.

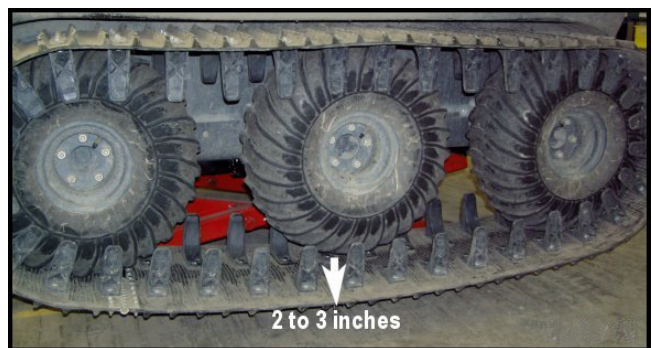

Figure 11-13. Measuring the gap of the mid tire - Frontier.

SECTION 11 ACCESSORY INFORMATION

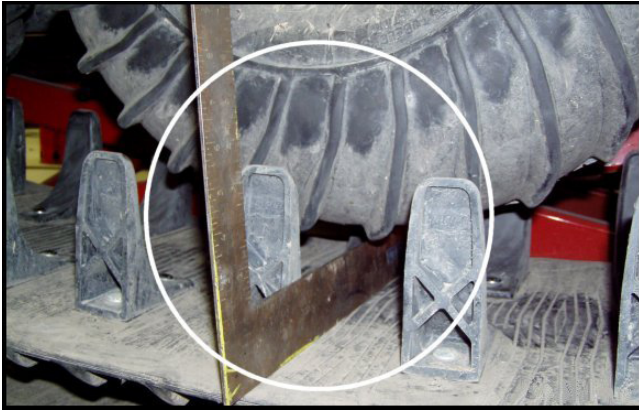

Figure 11-14. Measuring the gap of the mid tires - Frontier.

11.3.10 Removal of 625-50 & 825-50-1 Argo Rubber Track Systems

1. Use a "C" clamp style vise grip to take the tension off the pin. Remove the flat washer and cotter pin. With a drift punch and hammer, tap the pin until it can be grabbed and pulled from the hinge lacing.

If an Argo is taken outdoors into freezing temperatures after the track system has been installed indoors at normal room temperature, the tires will lose air pressure. After the tires have cooled down to the outdoor temperature where the vehicle is to be operated, the tire pressure should be rechecked and adjusted as required.

Extreme **CAUTION** is advised when crossing ice covered water. The vehicle may sink if it breaks through the ice surface and fills with water. Make sure drain plugs are securely in place, and do not overload the vehicle. Should the vehicle break through the ice, attempt to back the vehicle out. During this maneuver, take care that water does not enter the engine compartment. Refer to the Argo operator's manual for additional information on safe operation in water.

Under certain winter conditions, such as a rapid drop in temperature after a mild period, slush can build up on the track to the point that the ARGO may be unable to move. Stop periodically to clean snow and ice from the axles and track components to prevent buildup.

⚠ CAUTION

Maximum Total Load Capacity in Water of a Frontier with Rubber Tracks is 160 kg (350 lbs.) and an Avenger is 365 kg (800 lbs.)

⚠ CAUTION

Observe all operating precautions as outlined in 11.3.4 of this Accessory Section.

11.4 ICE CLEAT ASSEMBLY (Part Nos. 625-20, 825-20 & 825-21)

ARGO ice cleats are stamped steel cleats that bolt to the outer edges of the Rubber Tracks or Super Track segments to grip on hard pack snow and ice to improve traction and stopping.

⚠ WARNING

Make sure all passengers riding in an Argo equipped with ice cleats are informed to keep hands, feet and clothing inside the vehicle, well away from the tracks and ice cleats while the Argo is in motion. Serious injury or death could result from getting caught by the ice cleats.

⚠ CAUTION

Installing Argo ice cleats or any other traction device on the in-board side of the track segment, close to the lower body, may cause damage to the lower body if contact results while the vehicle is being driven.

11.5 OUTBOARD MOTOR BRACKET - SIDE MOUNT (Part Nos. 617-09 & 617-10)

The side mount outboard motor bracket attaches to the right rear of any Argo model. It allows the attachment of a gasoline or electric outboard motor of 9.9 horsepower maximum. When traveling on land it is recommended that the outboard motor be transported in the rear compartment of the Argo.

Use caution when turning in confined spaces or close to bystanders. Personal injury or damage may result.



Figure 11-15. Warning Label 618-21.

SECTION 11

ACCESSORY INFORMATION

11.6 ARGO STORAGE COVERS (Part Nos. 621-21; 821-20 & 821-40)

The Argo storage covers prevent debris, rain water or snow from accumulating in the Argo. Secure the cover by pulling it down over the bumper and tying the cord tightly in place. A cord or tie strap through the side grommets and under the vehicle lower body securely holds the cover in place in windy conditions.

⚠ CAUTION

Damage may result to the cover if the vehicle is transported at highway speeds with the cover in place. If the cover must be used while transporting the vehicle, damage may be minimized by placing padding over sharp corners such as the tail pipe or the winch and tying the cover securely in place against the Argo body.

11.7 POWER WINCH (Part Nos. 622-105 & 622-110)

The power winch mounts to the front of the Argo and can be used for self-recovery and to raise and lower the snowplow blade (Part No. 657-00). The winch has a free-wheeling feature that allows the cable to be pulled off the winch drum without using the 12 volt electric motor.

The electrical components and the wiring design of the winch kit prevents the use of the winch motor unless the ignition key is turned to the 'on' position. This is a safety feature that prevents the unauthorized use of the winch when the vehicle is parked.

After the installation of the winch kit is completed, test the electrical connections by moving the toggle switch control from side to side with the ignition switch removed. If the winch DOES NOT operate the connections are correct. If the winch starts during this test have the installer correct the wiring connections immediately.

⚠ CAUTION

11.7.1 Rules For Safe Operation

1. The winch is rated at 3,000 pounds (single-line) capacity. **DO NOT OVERLOAD. DO NOT ATTEMPT PROLONGED PULLS AT HEAVY LOADS. DO NOT MAINTAIN POWER TO THE WINCH IF THE MOTOR STALLS.** Overloads can damage the winch and/or the wire rope and create unsafe operating conditions. For heavy loads, we recommend the use of the optional pulley block and hook assembly (Warn Part No. 28881 or Superwinch Part No. 1503) to double line the wire rope (Figure 11-16). This reduces the load on the winch and the strain on the wire rope by approximately 50%.

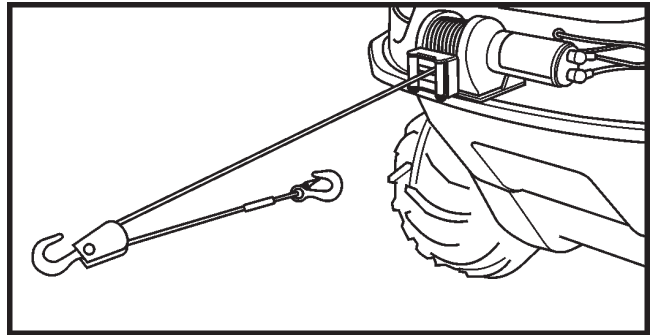

Figure 11-16 Double Line.

2. Periodically check the winch installation to assure that all bolts are tight.
3. **DO NOT** “move” your vehicle to assist the winch in pulling a load. The combination of the winch and vehicle pulling together could overload the wire rope and the winch itself.
4. **KEEP WINCHING AREA CLEAR.** Do not allow people to remain in the area during winching operations. Do not step over a taut wire rope or allow anyone else to do so. Do not stand between the winch and the load.
5. **INSPECT WIRE ROPE AND EQUIPMENT FREQUENTLY.** A frayed wire rope with broken strands should be replaced immediately. Always replace wire rope with the manufacturer’s identical replacement part, Warn Part No. 60076 or Superwinch Part No. 1513.
6. **USE HEAVY LEATHER GLOVES** when handling wire rope. Do not let wire rope slide through your hands. A broken strand could seriously injure your hands.
7. Keep clear of winch wire rope and hook when operating winch. Never put your fingers through the hook when reeling in the last few feet of line. If your finger should become trapped in the hook, you could lose your finger. Use the **HANSAVER STRAP** (Figure 11-17) to guide the hook within the last few feet. Never guide a wire rope onto the drum with your hand.

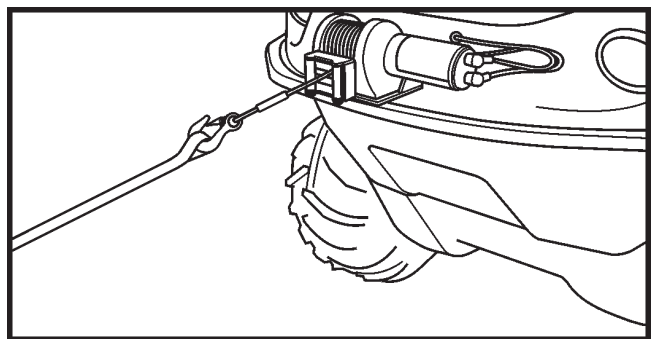

Figure 11-17. Using the Handsaver Strap.

SECTION 11

ACCESSORY INFORMATION

8. NEVER HOOK THE WIRE ROPE BACK ONTO ITSELF. Use a nylon sling. (Figure 11-18.) Hooking the wire rope onto itself can damage the rope (Figure 11-19).

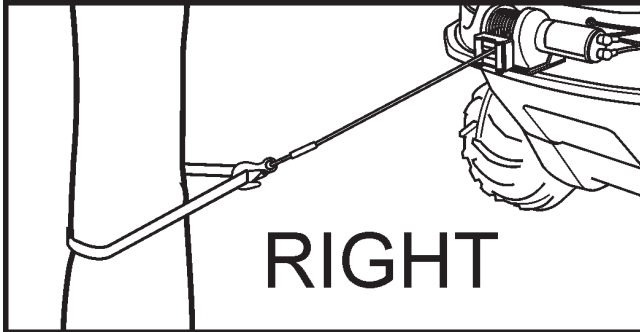

Figure 11-18. Correct hook-up.

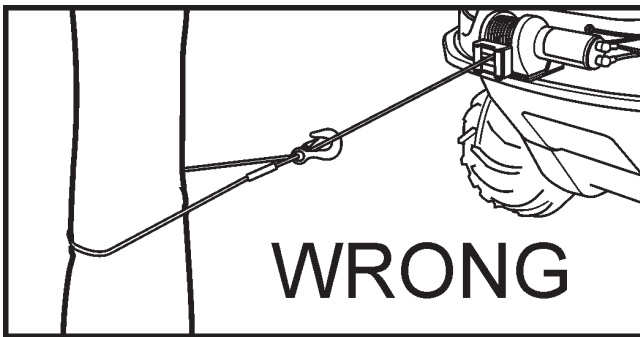

Figure 11-19. Incorrect hook-up.

9. It is a good idea to lay a heavy blanket or jacket over the wire rope near the hook end when pulling heavy loads (Figure 11-20). If a wire rope failure should occur, the cloth will act as a damper and help prevent the rope from whipping.

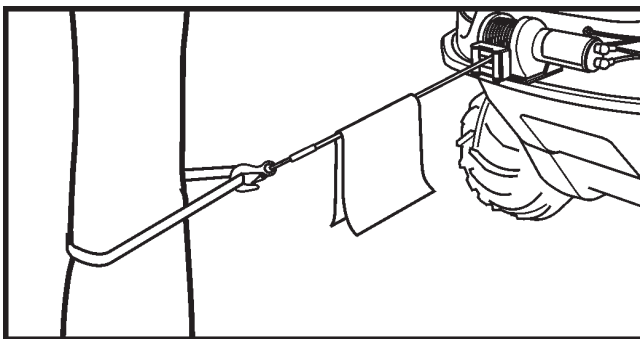

Figure 11-20. Using a cloth damper.

10. Your winch is not designed or intended for overhead hoisting operations. Never use your winch for lifting or moving people.

11. Avoid continuous pulls from extreme angles as this will cause the wire rope to pile up at one end of the drum (Figure 11-21 & Figure 11-22). This can jam the wire rope in the winch causing damage to the wire rope or the winch itself.

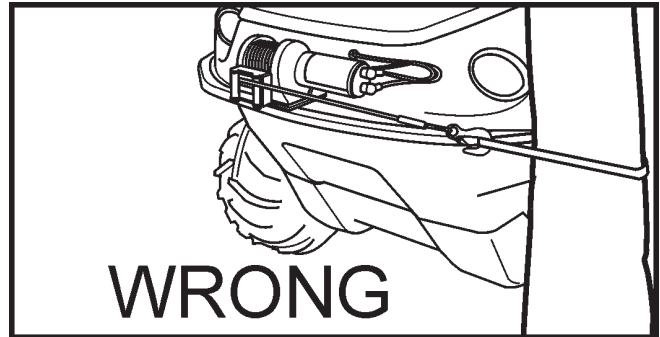

Figure 11-21. Incorrect positioning for continuous pulls.

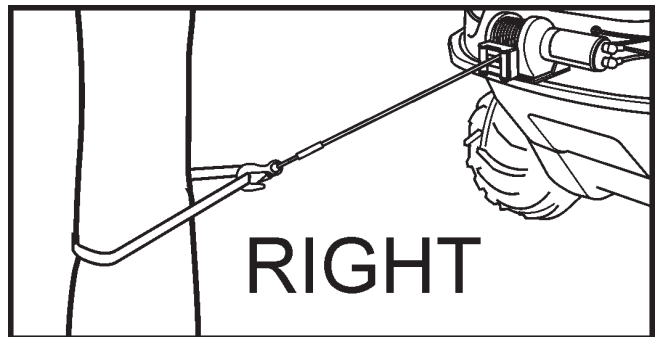

Figure 11-22. Correct positioning for continuous pulls.

12. Always operate the winch with an unobstructed view of the winching operation.
13. Do not operate the winch when under the influence of drugs, alcohol or medication.
14. Never work on or around the fairlead or winch drum when the winch is under load.
15. When using your winch to move a load, place the vehicle transmission in neutral, set vehicle parking brake, chock all wheels, and keep the engine running.
16. Do not use the winch to hold the Argo in place during transportation. Use tie-down straps.
17. Maintain at least five turns of wire rope around wire rope drum to prevent the wire rope from pulling off under load.

SECTION 11

ACCESSORY INFORMATION

11.7.2 Tips for Extending the Life of Your Winch

1. Keep a tightly and evenly wound wire rope drum. Do not allow the wire rope to become loosely wound. A loosely-wound spool allows a wire rope under load to work its way down into the layers of wire rope on the drum. When this happens, the wire rope may become wedged within the body of the windings damaging the wire rope. To prevent this problem, keep the wire rope tightly and evenly wound on the drum at all times. During winching, periodically check to see that the wire rope is winding on evenly. A good practice is to rewind the wire rope under tension after each use. One way to do this is to attach the hook to a stationary object at the top of a small hill or incline and winch your vehicle up the incline.
2. Do not allow motor to overheat. Remember, the winch is only for intermittent use. During long or heavy pulls the motor will get hot. The internal parts will be hotter than the case. To check the motor temperature, stop winching and carefully touch the end of the motor. If the motor is uncomfortably warm, allow the motor to cool before continuing — keep the engine running to recharge the battery during this break.
3. Use a pulley block for heavy loads. To maximize winch and wire rope life, use a pulley block (Warn Part No. 28881 or Superwinch Part No. 1503) to double line heavier loads.
4. The pull required to start a load moving is often much greater than the pull required to keep it moving. Avoid frequent stopping and starting during a pull.
5. Prevent kinks before they occur.
 - (1) This is the start of a kink. At this time, the wire rope should be straightened.

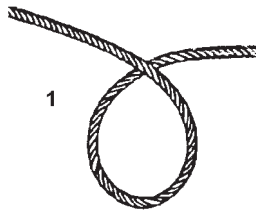

- (2) The wire rope was pulled and the loop has tightened to a kink. The wire rope is now permanently damaged and must be replaced.



- (3) The result of kinking is that each strand pulls a different amount, causing the strands under greatest tension to break and reduce load capacity of the wire rope. The wire rope must be replaced.



11.8 REAR MUD FLAP ASSEMBLY (Part No. 625-10)

Argo mud flaps are made of black polyethylene sheet cut to conform to the curve of the rear corners of the lower body. They are recommended for use with either track system to block the mud and snow thrown up during higher speed travel.

11.9 BILGE PUMP ASSEMBLY (Part No. 638-30)

The bilge pump kit features a 12 volt, 500 gallon per hour pump to empty water from the lower body. Operated by a dash mounted push/pull switch, the bilge pump is recommended for any amphibious use of an Argo.

! CAUTION

The pump is not designed to run dry. Use only when water has collected in the lower body.

11.10 HANDRAIL ASSEMBLY (Part Nos. 639-26, 839-30 & 839-35)

Handrails mount to the top of the upper body around the rear compartment, providing a convenient passenger hand hold or cargo tie down point.

! CAUTION

Do not attempt to lift the vehicle by using the handrails.

11.11 TOW HOOK ASSEMBLY (Part No. 642-00)

The tow hook kit is a steel fabrication that bolts securely through the bumper and both body halves at the front or rear of the vehicle.

! CAUTION

The tow hook is not intended to secure an Argo to a trailer or truck bed. Body deformation could result from a downward pull.

SECTION 11 ACCESSORY INFORMATION

11.12 WINDSHIELD (Part Nos. 648-79 & 648-80)

The windshield features an anodized aluminum frame with rubber mounted 24" high x 48" wide laminated safety glass. It mounts to the top of the dash area of any Argo model, folds down and secures in place over the hood and is required for the convertible top.

⚠ CAUTION

When the windshield is raised in the upright position, it must be supported by the two side support arms. Attach both support arms to the windshield frame brackets using the quick pins supplied. Do not attempt to fasten the front of a convertible top to the windshield until the support arms are in place.

DO NOT transport the Argo at highway speeds with the windshield upright. For transportation at highway speeds, it is recommended that the vehicle be reversed on the truck or trailer so that the front of the Argo faces to the rear. The windshield should be folded down and secured in place using a rope or a tie down strap.

⚠ CAUTION

Operating the Argo for extended periods in high ambient temperatures with the windshield in the folded down position may restrict hot air flow from the engine compartment which could lead to engine overheating and heat build-up in the windshield frame and glass. Use caution when operating the vehicle with the windshield folded down to avoid overheating in warm temperatures.

The following decal should be attached to the inside of the windshield:

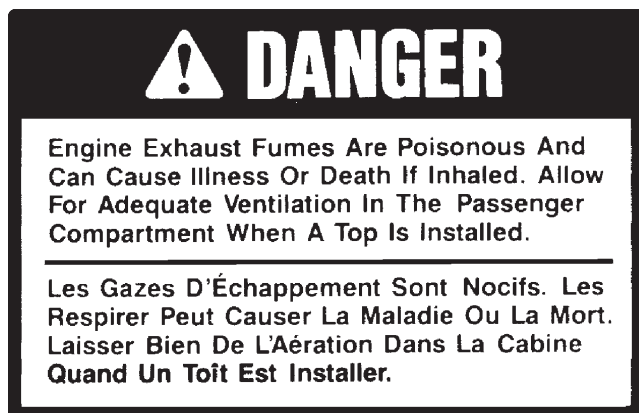

If this decal is not attached to the windshield, contact your Argo retailer for a free-of-charge replacement. The part number is 126-84.

11.13 CONVERTIBLE TOP (Part Nos. 649-51, 849-40, 849-45 & 849-51)

The convertible top provides protection from the elements for the occupants and offers the option of rolling up or removing the side doors, rear door and rear side panels while leaving the overhead portion in place.

⚠ CAUTION

Never fold the clear plastic windows; always roll them up to store them in place on the top assembly or remove them.

To fold the convertible top for storage, unzip the side and rear doors and the side panels, lay them aside and unsnap the domes along the front of the roof panel from the windshield frame. Fold the aluminum top frames together and roll the overhead panel around the frames loosely. Then, roll the window panels around the top material so the boot will cover the complete assembly for protection.

⚠ CAUTION

The convertible top assembly is not designed to withstand the turbulence created while transporting the vehicle with the top assembled in the 'up' position. Fold the top down and secure it properly to the vehicle body or remove it from the vehicle for high speed transportation.

⚠ WARNING

Hearing protection is strongly advised when operating the vehicle equipped with any convertible top assembly.

The following decal should be attached to the inside of the windshield:

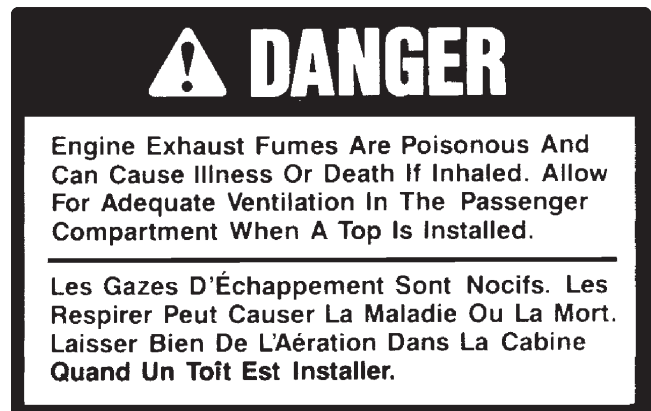

If this decal is not attached to the windshield, contact your Argo retailer for a free-of-charge replacement. The part number is 126-84.

SECTION 11

ACCESSORY INFORMATION

11.14 ALTERNATOR ASSEMBLY - For Avenger (Part No. 850-54)

The externally mounted, belt driven, 40 amp alternator is recommended when electrical accessories such as a winch are added to the vehicle.

There is a red charge indicator light installed in the dash, to the right of the ignition switch. If the red light comes on, the alternator is not sending a charge to the battery. This may simply be a result of low engine idle speed. If the light stays on at vehicle operating speeds, have your Argo retailer service the system soon.

Check the V-belt tension frequently to be sure belt deflection is no more than 1/8" or 3 mm with approximately 6 lbs. or 3 kgs of force applied to the belt, halfway between the pulleys. Adjust the belt tension as necessary. Failure to do so will reduce the charge rate and lead to battery failure.

11.15 SNOW PLOW ASSEMBLY (Part No. 657-21)

The snow plow assembly attaches to the front of the Argo at two mounting brackets that bolt to the front axle bearing extension housings. The plow blade is raised and lowered by operating the power winch in and out.

WARNING

DO NOT STAND BETWEEN THE PLOW BLADE AND THE FRONT OF THE ARGO. Injury could result if the blade is raised.

The vehicle operator must observe caution when operating the vehicle and snow plow in the presence of others. Injury could result if a bystander is struck when the vehicle swings to turn or the blade is lowered onto someone's foot. Always be aware of the area being plowed. Although there is a blade trip mechanism feature of the blade, damage or operator injury could result from hitting rocks, stakes or curbs hidden under the snow being plowed.

To avoid serious injury or death:

- *Do NOT operate the vehicle on open or frozen bodies of water with the snow plow attached.*
- *Do not exceed 8 kph (5 mph) with blade installed.*
- *Plow cautiously. Impact with hidden or stationary objects may cause the vehicle to stop suddenly or go out of control.*
- *Operate with extreme caution on slopes. Do not operate the plow on steep grades and rough terrain.*

- *Keep bystanders away from the blade or vehicle while moving or stationary.*
- *Never put feet or hands under plow blade.*
- *Inspect plow mechanism, fasteners, cables, and ad-justments before operating. Replace all worn or damaged components before operating.*
- *Lower the plow to the down position before leaving the vehicle unattended.*

11.16 AMPHIBIOUS TRAILER (Part Nos. 695-75 & 695-80BL)

The Argo four wheel amphibious trailer is designed as an additional cargo carrier for any Argo model. It is not intended for the transportation of people. Trailer load capacity is 600 lbs or 270 kg at a recommended tire pressure of 4 psi.

11.16.1 Operating Precautions

Keep cargo low and centered in the trailer, especially if used in the water. Secure the load in place to keep it from shifting when traveling in uneven terrain. Avoid sudden stops when towing the trailer downhill to prevent the trailer from colliding with or passing the Argo.

Do not step on or place loads on the edge of the body over the trailer wheels. This area of the trailer body is intended only as a mud guard.

Follow the instructions listed in Section 6.4.5 of this manual to service the axle bearings. Do not allow water and debris to accumulate in the bottom of trailer body to avoid premature bearing failure.

WARNING

Keep fingers clear of tongue swiveling components.

11.17 HEATER ASSEMBLY - Avenger (Part No. 848-32)

The heater kit includes a conventional automotive style hot coolant heater core with 2 speed fan to circulate the warm air through the ducts to the right side of the driver's compartment and the windshield. In some operating conditions, ie. high humidity or full passenger load, defrosting the windshield and side panel windows may not be effective.

In extremely cold weather and operating at low load, the heater may perform like a second radiator and keep the engine from reaching proper operating temperature. Under these conditions, a piece of cardboard or similar material should be used to partially cover the engine radiator.

SECTION 11

ACCESSORY INFORMATION

11.18 ROLL OVER PROTECTIVE STRUCTURES (Part Nos. 648-47, 849-90-2 & 849-90-4)

The optional Rollbar (see Section 11.20) or optional Roll Over Protective Structure, also referred to as a ROPS, provides additional protection for the occupants in case the vehicle overturns, *provided all occupants wear seatbelts.*

However, Rollbars and ROPS also introduce additional hazards that have to be carefully weighed against the safety benefits of these devices:

- If your vehicle is equipped with either a Rollbar or ROPS, always remember that your vehicle is now more top heavy. This reduces the vehicle's stability both on land and in the water. Therefore, *always* wear your seatbelt when driving on land, but *never* when driving in the water. The increased instability and weight may mean that you will no longer be able to maneuver some slopes with either a rollbar or ROPS installed. Follow all weight restrictions and, as always, drive slowly and carefully.
- A 6 wheeled Argo with ROPS installed should not be used in water at any time.
- Be particularly careful when driving under trees, as low-hanging branches can upset your vehicle.
- Never place or carry anything on top of the ROPS.

Roll Over Protective Structures (ROPS) are designed for use on all Argo models. Part No. 848-40-2 provides roll over protection and lap belts for the driver and front seat passenger of all Argo 8 x 8 models except the Avengers. Part No. 848-40-4 provides roll over protection and lap belts for driver, front seat passenger and two passengers in the optional rear bench seat (Part No. 849-60). Part Nos. 849-90-2 and 849-90-4 fit the 8x8Avenger and Frontier models. Part No. 648-47 provides roll over protection and lap belts for driver and front seat passenger of all 6x6 Frontiers.

The ROPS design provides reasonable protection from injury in the event of a rollover. DO NOT rely on it to protect the occupants from irresponsible driving.

The ROPS has been designed to meet the requirements of the Occupational Health and Safety Act - Regulation 856 'Roll-Over Protection Structures' for the Province of Ontario, Canada.

WARNING

Seat belts must be properly adjusted and worn by all occupants at all times EXCEPT when operating in water. 6x6 vehicles equipped with 648-47 ROPS should not be used in water operation. Never carry more people in the vehicle than there are seat belts for.

Articles must not be placed on top of the ROPS.

Use caution when travelling on uneven ground; the ROPS reduces vehicle stability.

No part of the ROPS shall be drilled, welded or altered in any way without the manufacturer's authorization.

Do not exceed maximum gross vehicle weight of 907 kg (2000 lb.), Avenger 1066 kg (2350 lb.).

Use caution when travelling tree-lined trails. Branches could be knocked down, causing injury to the vehicle occupants.

FAILURE TO COMPLY WITH THE ABOVE COULD RESULT IN PERSONAL INJURY OR DEATH.

CAUTION

DO NOT use the ROPS as an attachment point for towing or winching the Argo.

Check fastener tightness annually. Inspect for and replace any damaged or worn parts of the ROPS and the seat belts.

11.19 REAR BENCH SEAT (Part No. 849-80)

This bench seat assembly is similar to the front bench seat design, providing a back rest and more comfort for two persons riding in the rear compartment of any current Argo 8 x 8 model. The seat cushion and back rest are easily removed to use the rear compartment for cargo.

CAUTION

Always ensure that the spring loaded pull pin (Part No. 849-72) on each side is fully engaged after installing the seat. Pull the seat hard to ensure that it is secured properly.

Never attach a tow line to the handrail of the seat back rest.

When a roll over protection structure (ROPS) is installed, seat belts must be installed for rear bench seat passengers and used properly.

SECTION 11 ACCESSORY INFORMATION

11.20 ROLL BAR ASSEMBLY (Part No. 648-15)

The roll bar is designed for use on all Argo 6 x 6 models. The roll bar provides some roll over protection and lap belts for the driver and front seat passenger.

WARNING

When the Roll Bar Kit is installed, ALWAYS wear seat belts when operating the vehicle on land. REMOVE seat belts when entering water.

Maximum total vehicle weight must not exceed 1465 lbs. or 665 kg. which means 2 people and 100 lbs. or 46 kg. of cargo in the vehicle.

Never attach anything to the Roll Bar other than Ontario Drive & Gear 648-15 Roll Bar specific accessories.

The Roll Bar reduces vehicle stability. Always use common sense when traveling over rough terrain.

The Roll Bar is designed to reduce the chance of injury. DO NOT rely on it to protect the vehicle occupants from irresponsible driving.

The Roll Bar could come in contact with tree branches. Falling branches or vehicle upset could occur. Use extreme caution when traveling on narrow tree lined trails.

DO NOT use the Roll Bar as an attachment point for towing or winching.

Check the torque of the Roll Bar nuts and bolts annually and replace any parts that are damaged. When the Roll Bar is installed, never carry more than two people in the Argo.

Replace worn or damaged seat belt straps and buckles.

Failure to comply with the above could result in personal injury or death.

11.21 12V ACCESSORY OUTLET ASSEMBLY (Part No. 633-25)

The 12V Accessory Outlet Kit contains a 12V outlet, wire harness complete with in-line fuse holder & fuse, and the necessary hardware to mount the outlet in the upper body of any Argo model. When mounting the outlet, be sure to select an area within reach for the wire harness. The wire harness gets connected directly to the battery terminals so any mounting location chosen, must allow the harness to reach both the outlet and the battery. When mounting, be sure that the wire harness is securely clipped into place and not left dangling near moving parts within the engine compartment.

CAUTION

Because the outlet is wired directly to the battery, it is constantly "live," even without the key turned on. Excessive use will run down the battery.

CAUTION

This outlet is NOT designed to support nor should it be used as a cigarette lighter socket.

11.22 BRUSHGUARD ASSEMBLY (Part Nos. 642-20 & 642-40)

The Brushguard Kit protects the winch and headlights from damage by the brush encountered along the trail. It features an integrated tow hook. Installation of mounting kit or power winch is required.

APPENDIX 1 SPECIAL TOOLS

7R VICE GRIP MODIFICATION (Part No. 658-08)

As detailed in Section 7, a pair of modified 7R Vice Grips is required to hold the ends of the drive chain together while inserting the connecting link. This tool can also be used to hold the ends of the idler chain together while inserting the connecting link. Grind the undercut and sides of the vice grip jaw to fit over 2 chain rollers. The undercut is approximately 1/4" radius as shown.

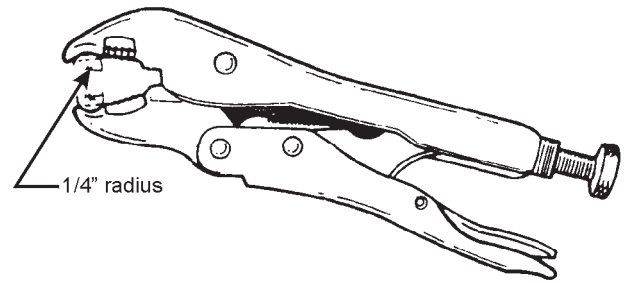

ARGO New Vehicle Limited Warranty

The warranty period is limited to 12 months from the date of the original retail sale, with the following exceptions:

Briggs & Stratton Engine – 24 months from the date of retail sale separately by the engine manufacturer's service network.

Kohler Engine – 36 months from the date of retail sale separately by the engine manufacturer's service network.

Exide Battery – Factory supplied OEM Exide batteries are warranted for 12 months free replacement from date of retail sale by the battery manufacturer's service network, 60 months warranty pro-rated.

Superwinch and Warn winches (not installed by dealer at time of purchase) – 12 months from the date of retail sale separately by the winch manufacturer's service network.

Tires - 3 months from the date of retail sale

Genuine ARGO accessories purchased and installed by the factory or authorized dealer at the time of purchase are covered under the 12 month ARGO New Vehicle Limited Warranty. Only those accessories listed on the original warranty registration form will be covered.

Ontario Drive & Gear Limited hereby warrants to the original retail purchaser that each new and unused ARGO is free from any defect in material or workmanship for the warranty period specified, under normal use and service by the original purchaser.

This warranty is void unless the vehicle has been properly warranty registered and the pre-service checklist has been completed by an authorized dealer.

This warranty is not transferable unless approved by Ontario Drive & Gear Limited.

This warranty is void immediately upon the ARGO being used in any speed contest (racing, dragging, etc.).

This warranty does not cover the following items:

1. Machines or parts lost or damaged during shipment.
2. Normal maintenance, as outlined in the maintenance schedule found in the Operator's Manual, or adjustments after initial pre-servicing is completed.
3. Normal replacement of service items, as outlined in the maintenance schedule found in the Operator's Manual.
4. Accessory items other than genuine Argo accessories.
5. Damages resulting from:
 - misuse, accident, theft or fire
 - use of improper or insufficient fuel, fluids or lubricants
 - use of parts other than genuine ARGO replacement parts
 - modifications, alteration, tampering or improper repair performed by parties other than an authorised ARGO dealer or distributor
 - any device or accessories installed by parties other than an authorised ARGO dealer or distributor
6. Batteries that fail due to improper charging or installation; broken container, cover or terminal sulphation or dehydration; damage caused by fire, excessive heat, wreckage, explosion, freezing, the addition of any chemical or solution other than the battery grade sulphuric acid.

This shall constitute the complete and only warranty given by Ontario Drive & Gear Limited, and, except as specifically set forth in the foregoing, Ontario Drive & Gear Limited shall not, in any event, be liable for any losses, damages or costs; to include travel, transportation, pick up, delivery, towing cost, loss of use, whether special, incidental, consequential or otherwise, in any way related to any vehicle or its sale. No warranty, expressed, implied or statutory, as to merchantability, fitness for a particular purpose, description, quality or any other matter is given in connection with any ARGO vehicle or its sale and no agent, employee or other person has any authority to vary any of the foregoing provisions. Provided, however, that this clause shall be severable where voided by application of the Consumer Protection Act.

Ontario Drive & Gear Limited, 220 Bergey Court, New Hamburg, Ontario, Canada, N3A 2J5
Sales Department 1-800-298-1118 x 374 sales@argoatv.com

ARGO RETAILER... Please complete this page at the time of sale to the new owner so your customer has all pertinent information that may be required.

ARGO MODEL _____

ARGO SERIAL NO. _____

ENGINE SERIAL NO. _____

TRANSMISSION SERIAL NO. _____

SOLD TO: _____

STREET ADDRESS: _____

CITY OR TOWN: _____ PROV/STATE: _____

POSTAL/ZIP: _____

DATE OF SALE: _____

WARRANTY PERIOD EXPIRES: _____

DEALER NAME: _____

PHONE: _____

ADDRESS: _____

CITY/TOWN: _____ PROV/STATE: _____

ARGO PRODUCTS MANUFACTURED BY:

**Ontario Drive & Gear Limited
220 Bergey Court
New Hamburg, Ontario
N3A 2J5 Canada
Phone: (519) 662-2840
Fax: (519) 662-2421
www.argoatv.com**